

datavideo

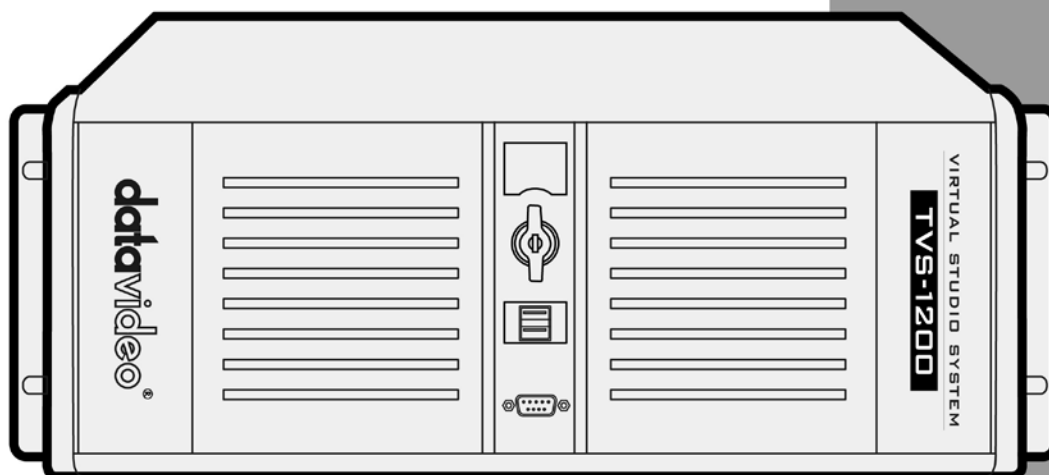

**TRACKLESS VIRTUAL
STUDIO SYSTEM**

TVS-1200

Instruction Manual

www.datavideo.com

Table of Contents

WARRANTY	4
STANDARD WARRANTY	4
TWO YEAR WARRANTY	4
DISPOSAL	4
CHAPTER 1 OVERVIEW	5
1.1 FEATURES	5
CHAPTER 2 TVS-1200 TRACKLESS VIRTUAL STUDIO SETUP	7
2.1 SYSTEM REQUIREMENT	7
2.2 CONNECTIONS.....	7
2.2.1 <i>Front Panel</i>	7
2.2.2 <i>Back Panel</i>	7
2.2.3 <i>Input/Output Card Options</i>	8
2.3 REMOVABLE HARD DISK INSTALLATION.....	9
2.4 SYSTEM DIAGRAM.....	10
2.5 RMC-220 REMOTE CONTROLLER.....	11
2.5.1 <i>Control Panel Overview</i>	12
2.5.2 <i>Main Unit - Rear Panel</i>	12
2.5.3 <i>Program and Preset rows</i>	13
2.5.4 <i>Preview and Program Switching</i>	13
2.5.5 <i>Downstream Keyers</i>	14
2.5.6 <i>Function Keys</i>	14
2.5.7 <i>Keyboard Backlight</i>	15
2.5.8 <i>Dimensions</i>	15
2.5.9 <i>Specifications</i>	15
CHAPTER 3 STARTING TVS-1200 SOFTWARE	17
3.1 PRODUCTION LIVE.....	18
3.2 STILL TEXT EDIT	18
3.3 VIRTUALSET MAKER.....	18
3.4 RICH SITE SUMMARY (RSS)	19
3.5 VIRTUALSET SHOP	19
3.6 CONFIGURATION	19
3.7 SHUTDOWN.....	21
CHAPTER 4 VIRTUALSET MAKER	22
4.1 FEATURES	22
4.2 GETTING STARTED.....	23
4.3 VIRTUALSET MAKER TOUR.....	24
CHAPTER 5 PRODUCTION LIVE SCREEN	33
5.1 TOOL BAR	33
5.2 MULTI-VIEW AREA.....	35
5.3 PROGRAM AND PREVIEW ROWS & FUNCTION SETTINGS.....	35
5.3.1 <i>10-input Main Switcher</i>	36
5.3.2 <i>Switching between Preview and Program Views</i>	36
5.3.3 <i>Downstream Keys</i>	37
5.4 VIRTUAL BACKGROUND EDITING	38

5.4.1	Import.....	39
5.4.2	Placement	40
5.4.3	Auto Play.....	41
5.5	FILE MANAGEMENT	43
5.6	ADDITIONAL MONITOR SUPPORT	46
5.6.1	General Display Settings	47
CHAPTER 6	CHROMA AND LUMA KEYS.....	49
6.1	KEY SELECTION	49
6.2	CHROMA KEY	49
6.3	MATTE CONTROL.....	50
6.4	TOLERANCE CORRECTION.....	52
6.5	SPILL CORRECTION	54
6.6	EDGE CORRECTION.....	56
6.7	GARBAGE MASK	56
6.8	POST CORRECTION	59
CHAPTER 7	FAST CHROMAKEYING	60
7.1	SIMPLE CHROMA KEY	60
7.2	WIZARD.....	60
CHAPTER 8	SOUND MIXER	61
CHAPTER 9	MOTION CAPTURE SPECIFICATION	62
CHAPTER 10	PROGRAM VIDEO STREAM	64
CHAPTER 11	EXTERNAL KEYBOARDS	65
11.1	RMC-220 FUNCTION KEYS	65
11.1.1	Advanced.....	66
11.1.2	Simple.....	67
11.2	STANDARD WINDOWS KEYBOARD SHORTCUTS.....	67
CHAPTER 12	SYSTEM RECOVERY.....	68
CHAPTER 13	FREQUENTLY-ASKED QUESTIONS.....	71
CHAPTER 14	SPECIFICATIONS.....	73
CHAPTER 15	TVS-1200 AUX CARD	74
15.1	INTRODUCTION.....	74
15.2	INSTALLATION.....	74
15.3	SPECIFICATION.....	74
SERVICE & SUPPORT	75

Disclaimer of Product and Services

The information offered in this instruction manual is intended as a guide only. At all times, Datavideo Technologies will try to give correct, complete and suitable information. However, Datavideo Technologies cannot exclude that some information in this manual, from time to time, may not be correct or may be incomplete. This manual may contain typing errors, omissions or incorrect information. Datavideo Technologies always recommend that you double check the information in this document for accuracy before making any purchase decision or using the product. Datavideo Technologies is not responsible for any omissions or errors, or for any subsequent loss or damage caused by using the information contained within this manual. Further advice on the content of this manual or on the product can be obtained by contacting your local Datavideo Office or dealer.

Warranty

Standard Warranty

- Datavideo equipment is guaranteed against any manufacturing defects for one year from the date of purchase.
- The original purchase invoice or other documentary evidence should be supplied at the time of any request for repair under warranty.
- Damage caused by accident, misuse, unauthorized repairs, sand, grit or water is not covered by this warranty.
- All mail or transportation costs including insurance are at the expense of the owner.
- All other claims of any nature are not covered.
- Cables & batteries are not covered under warranty.
- Warranty only valid within the country or region of purchase.
- Your statutory rights are not affected.

Two Year Warranty

- All Datavideo products purchased after 01-Oct.-2008 qualify for a free one year extension to the standard Warranty, providing the product is registered with Datavideo within 30 days of purchase. For information on how to register please visit www.datavideo-tek.com or contact your local Datavideo office or authorized Distributors
- Certain parts with limited lifetime expectancy such as LCD Panels, DVD Drives, Hard Drives are only covered for the first 10,000 hours, or 1 year (whichever comes first).

Any second year warranty claims must be made to your local Datavideo office or one of its authorized Distributors before the extended warranty expires.

Disposal

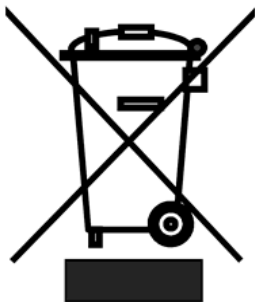

For EU Customers only - WEEE Marking

This symbol on the product indicates that it will not be treated as household waste. It must be handed over to the applicable take back scheme for the recycling of electrical and electronic equipment. For more detailed information about the recycling of this product, please contact your local Datavideo office.

Chapter 1 Overview

TVS-1200 is a computer-based 2D trackless Virtual Studio System. It is a real-time production system with very high quality live chromakeying.

TVS-1200 uses two fixed cameras and creates virtual cameras. This allows the director to zoom, pan and tilt the camera virtually within the set. Its innovative Virtual Set Maker enables users to create their own distinct, branded sets within minutes.

Furthermore, with two camera inputs and two keyers, TVS-1200 gives the user the capability to place two talents on one virtualset. TVS-1200 can also be used in a remote scenario whereby the images captured by the two cameras at two different sites are placed on one single virtualset.

Also Integrated into the system are tools to record the program output, broadcast live and stream over the Internet.

1.1 Features

Varieties of System Inputs with Front Object Integration:

- Two Camera Inputs;
- Media (videos) – two clips at the same time;
- Still images (bitmaps, text) – two at the same time;
- Text – two text compositions at the same time.

Additional Media Features

- A Media Bin is a simple-to-use interface that makes it possible to gather all the media necessary for programme broadcast in one place;
- The media can be transferred from the bin to virtual players, used on air or as a source in virtual studios;
- The system has six bin tabs for four kinds of media: videos, still images, and text;
- Logo insertion on virtual scene.

Virtual Background Features

- Loads up to four virtual studio views simultaneously;
- Defines movements of a virtual camera in different phases within every studio;
- Configurable Pan/Tilt/Zoom;
- Multi-Point Zoom;
- Virtual Studio backgrounds, which can be downloaded from Datavideo's virtual background database website;
- 30 free virtualsets available for downloads;
- CG-loaded backgrounds imported from external files, or edited by Still Text Editor.

Media Previews

- Camera preview (one or two at a time, depending on system configuration);
- Media preview (two at a time);
- Still image preview (two at a time);
- Text preview (two at a time);
- Up to four virtual studio previews;
- PREVIEW – presentation of the next element prepared for broadcast;

- PROGRAMME – presentation of the current programme broadcast (system output);
- Previews on multiple monitors (if monitors are connected to a workstation, it is possible to obtain different preview configurations, even on three monitors).

Supported Formats

- Format: 720p50 – image resolution: 1280 x 720
- Format: 720p60 – image resolution: 1280 x 720
- Format: 720p59.94 – image resolution: 1280 x 720
- Format: 1080p60 – image resolution: 1920 x 1080
- Format: 1080p59.94 – image resolution: 1920 x 1080
- Format: 1080p50 – image resolution: 1920 x 1080
- Format: 1080p30 – image resolution: 1920 x 1080
- Format: 1080p25 – image resolution: 1920 x 1080
- Format: 1080p24 – image resolution: 1920 x 1080
- Format: 1080i60 – image resolution: 1920 x 1080
- Format: 1080i59.94 – image resolution: 1920 x 1080
- Format: 1080i50 – image resolution: 1920 x 1080
- Format: 1080i25 – image resolution: 1920 x 1080
- Format: 1080i30 – image resolution: 1920 x 1080
- Format: 1080i29.97 – image resolution: 1920 x 1080

Video Processing Formats

- Video processing: 4:4:4 16-bit floating-point internal processing;
- Inputs and outputs: YUV 4:2:2;
- Capture in output format: 4:2:0;
- Streaming: 4:2:2.

Other Miscellaneous Features

- A Five-in-One System: Virtual Studio, Switcher, Character Generator, Recorder and Web Streaming
- Multi-Language Support;
- RMC-220 Remote Control;
- Audio Embedding Capability;
- Real time streaming;
- Hard Drive (HD) Recording;
- Virtualset Maker;
- Optional TVS AUX Card for an additional input.

Chapter 2 TVS-1200 Trackless Virtual Studio Setup

2.1 System Requirement

- ✓ Monitor x 1 (up to three monitors connected to choices of the HDMI x 1, DVI x 1, DisplayPort x 3)
- ✓ Keyboard
- ✓ SDI camera x 2

2.2 Connections

2.2.1 Front Panel

The front panel contains the RS-232 connection for operation with an external Datavideo RMC-220 control panel. Access to the front panel is protected with a keyed door. This provides protection against the system being accidentally switched off or reset or the data disk being removed.

It is recommended to position the workstation horizontally so as to ensure air flows reaching the front and the back panels. Fans providing appropriate system cooling are located behind the panels. The workstation case is designed to be mounted on a server rack and occupies a 4U space.



2.2.2 Back Panel



Power Supply Socket

Depending on the shipment destination and the user location, a power supply cord with a suitable plug will be supplied



Power On/Off Switch

Switches power On/Off
0 – OFF 1 – ON



PS/2 Keyboard / Mouse Combo Port



USB 2.0 Ports



Connection of an external standard USB keyboard and mouse



USB 3.0 Ports (Blue)



Connection of USB Wireless Dongle / Adapter **IF ANY**

Please note that if you do not find the USB wireless dongle in the box, the TVS-1200 System Unit that you receive may already have a built-in wireless network card.



LAN (RJ-45) Port

Connection of the workstation to a computer network

2.2.3 Input/Output Card Options

With both display and virtu SDI cards installed, it is thus possible to achieve different combinations of views on the monitors. For more information, please refer to [Configuration – Layout](#) section.

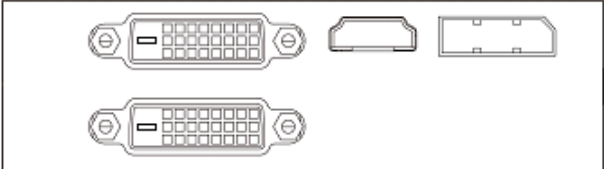
Display Card	
	<p>Display card allows connection of two DVI-D ports, one HDMI output port or one DisplayPort.</p> <p>Note: It is recommended to connect production window (Monitor 1) to HDMI port.</p>

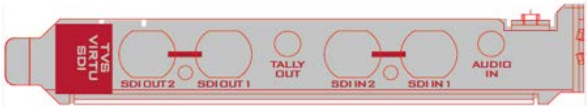
Virtu SDI Card	
	<p>Virtu SDI card allows connection of two SDI input/output pair, a mini phone jack for audio input and a tally output.</p>

2.3 Removable Hard Disk Installation

How to Assemble 2.5" HDD in Removable Rack

Warning: You must use TVS-1200 proprietary HDD and not any Datavideo HDR series or DN series.

Avoid HOT PLUGGING during operation (while writing to and reading from the disk) because it may cause damage to the system and files.

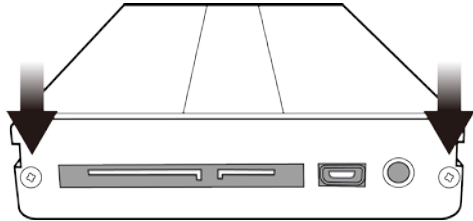

1. Remove the two screws on the rear cover of the removable 2.5" HDD enclosure and manually pull out the PCB

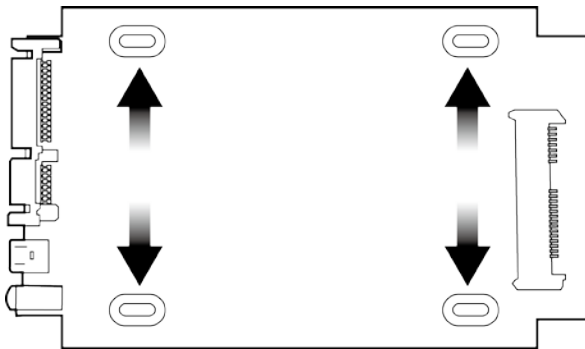

2. Tighten four screws to fasten 2.5" HDD on the PCB as shown in the diagram below

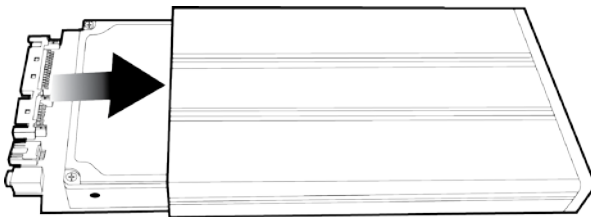

3. Push the PCB with 2.5" HDD into the HDD enclosure

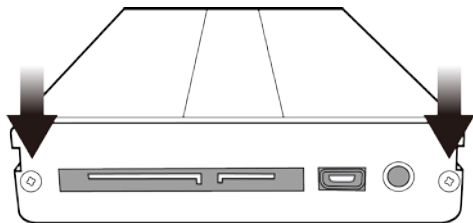

4. Tighten the two screws of the rear cover of the removable 2.5" HDD enclosure

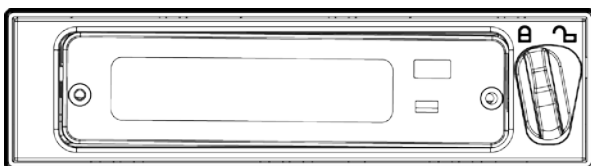

5. Push the removable 2.5" HDD enclosure into the front slot of TVS-1200 system

2.4 System Diagram

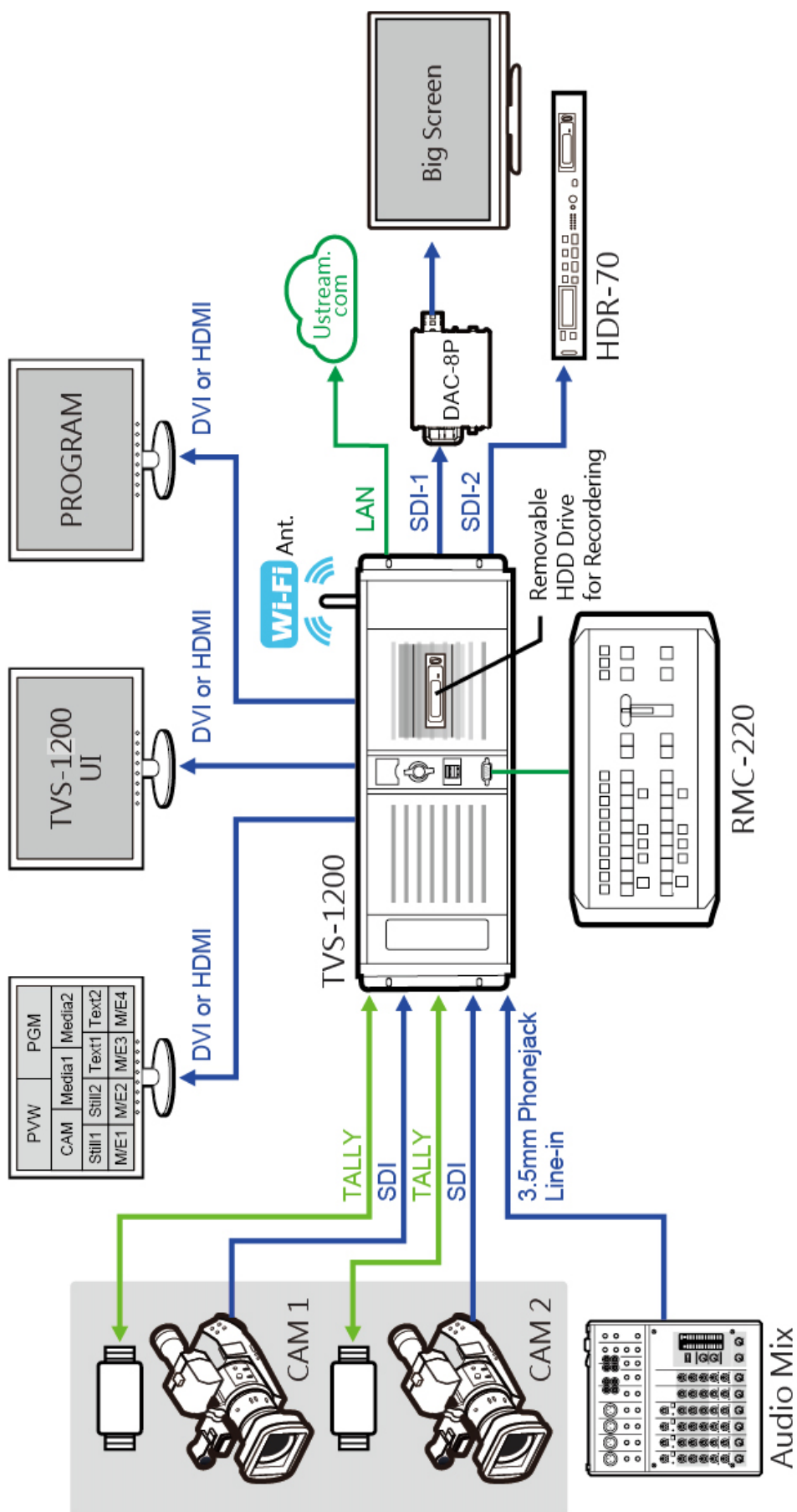

2.5 RMC-220 Remote Controller

The RMC-220 is a cost effective remote controller designed specifically for the TVS-1200 Virtual Studio System. The RMC-220 interfaces with the TVS-1200 Virtual Studio System via an RS-232 interface. The RMC-220 gives the user switcher-style control of the TVS-1200 Virtual Studio System. There are several effects that the user can also control on the RMC-220, such as downstream keyers (DSK), logo insertion, and transition effects. In addition, the T-Bar gives the user the convenience to perform transitions between Preview (PVW) and Program (PGM).

The RMC-220 has also been equipped with 10 function keys, which provide the user with the flexibility of manually assigning functions related to audio features, downstream keyer, delay, mix effect, media player functions and output effects to the 10 keys.

The features are summarized as follows,

- A switcher style keyboard for direct TVS-1200 operation
- Clear key definitions
- Ten user-defined function keys, F1 to F10 and each of these function keys can be:

Audio	DSK	General	Mix Effect	Media	Output
Capture Mute	Set Position	Delay	Import Studio	Auto Play	Select Preview
Capture Volume	Set Preview		Set AutoPlay	Loop Play	Select Program
Input Mute	Set Rotation		Set Bus A Source	Pause	Set T-Bar Position
Input Solo	Set Scale		Set Bus B Source	Play	Transition Cross-Dissolve
Input Volume	Set Source		Set Bus C Source	Select	Transition Fade to Black
Output Mute	Transition Cut		Set Phase	Stop	
Output Volume	Transition Fade		Set Speed		
Streaming Mute					
Streaming Volume					

- Program/Preset Rows with buttons allowing the user to switch between CAM1, CAM2, ME1, ME2, ME3, ME4, Media1, Media2, Still1 and Still2
- Three custom-set phase buttons for virtual camera lens zoom in/out
- Auto play button for automatic movement of the virtual camera
- T-Bar can be operated in one way or two way mode
- Take button to switch between PVW and PGM views
- FTB button fades the PGM view to a black screen
- Cross Dissolve button applies cross-dissolve transition effect to switching between PGM and PVW views
- Two downstream keyers (DSK) with two corresponding knobs for assignment of DSK sources
- Cut and Fade buttons transition DSKs between PGM and PVW views
- Stream button triggers live video program streaming
- Capture function records the live video program
- Still Grab function captures the instantaneous video image
- RS-232 interface for communication between RMC-220 and TVS-1200
- 12V DC input making the unit ideal for studio applications
- Bright LED lighting

2.5.1 Control Panel Overview

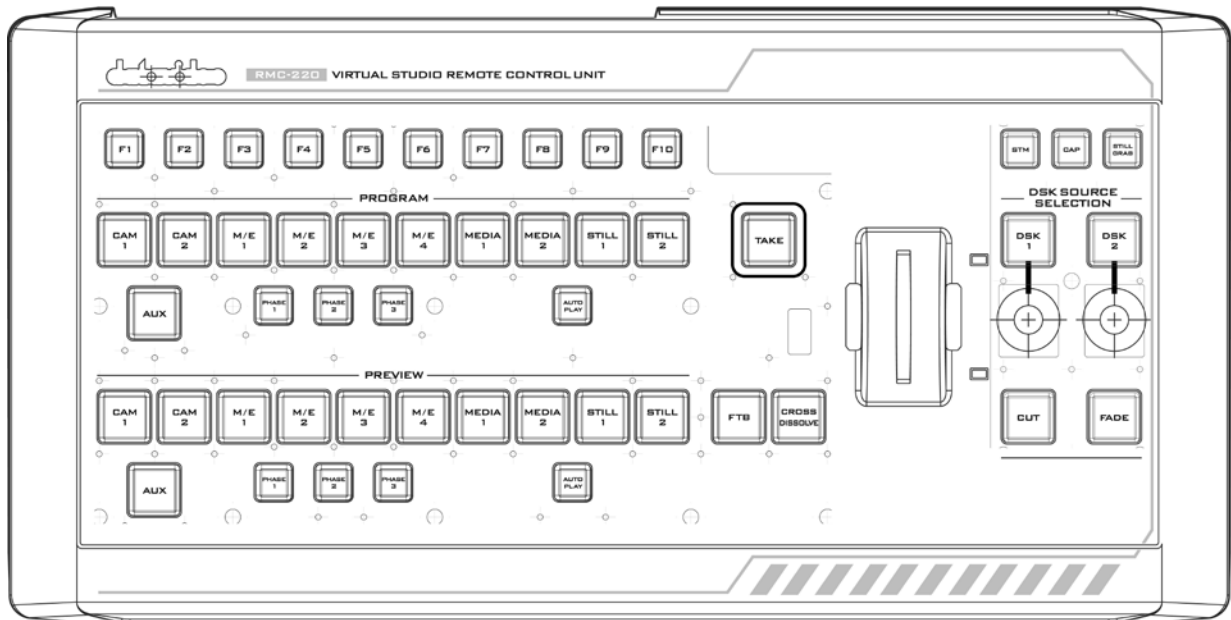

F1-F10	Function Keys F1 – F10	Phase 3	Phase 3 selection
CAM 1	Camera 1 view selection	Auto Play	Auto Play function
CAM 2	Camera 2 view selection	Take	Switch between PVW and PGM
M/E 1	M/E 1 view selection	FTB	Fade PGM to Black
M/E 2	M/E 2 view selection	Cross Dissolve	Cross dissolve transition effect
M/E 3	M/E 3 view selection	T-Bar	Manual Transition
M/E 4	M/E 4 view selection	STM	Program Streaming
Media 1	Media 1 Video selection	CAP	Video Recording
Media 2	Media 2 Video selection	Still Grab	Still Picture Grab
Still 1	Still Picture 1 selection	DSK 1	DSK 1 and source assignment knob
Still 2	Still Picture 2 selection	DSK 2	DSK 2 and source assignment knob
AUX	AUX Card Input selection	Cut	Placement of DSK on Program
Phase 1	Phase 1 selection	Fade	Gradual placement of DSK
Phase 2	Phase 2 selection		

2.5.2 Main Unit - Rear Panel

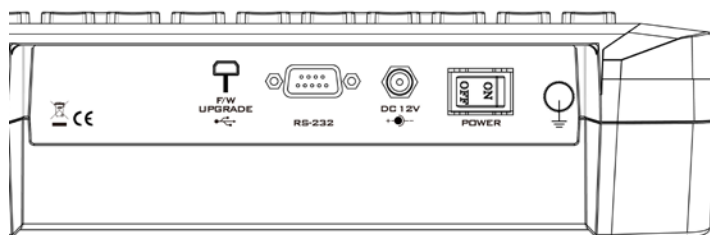

RS-232: RS-232 Communication Interface

DC 12V: 12V DC Power Input

ON/OFF: Power Button

2.5.3 Program and Preset rows

The Program row of buttons is for control of the program output; this is the live output. You can switch or CUT from one video source to another directly on the Program row. You will see the PGM output changes as you press different keys along this top row of buttons.

The Preset row of buttons is for control of the Preview window. The Preset row sets the next transitioned program by pressing the corresponding key to select the source.

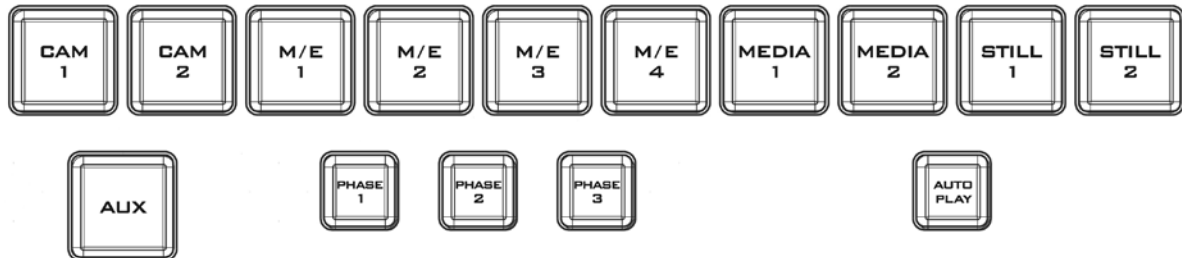

2.5.4 Preview and Program Switching



TAKE

This performs switching from the current program source to the selected preset source.



Cross-Dissolve

This performs a cross-dissolve switch from the current program source to the selected preset source.



FTB

Fade To Black, this button fades the current video program source to black. When pressed again it acts in reverse from complete black to the currently selected program video source.

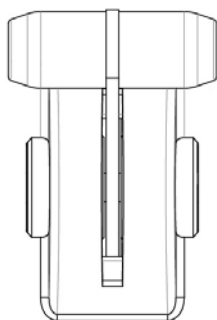

T-Bar

This performs a manually controlled transition from the current program source to the selected preset source. When the T-Bar has travelled as far as it can go, the transition between sources is complete.

2.5.5 Downstream Keyers



DSK 1/2

Pressing DSK 1/2 places logo or animations on the program view. Before placing the DSK on the program view, make sure it is correct on the PVW screen first.



Control Knob

Assigns a source to DSK 1/2 from a selection of camera, mix effects, video files, and pictures



Cut

This cuts from the current key source to the selected key source. Transition effect is not used.



Fade

This performs a fade transition switch from the current key source to the selected key source.

2.5.6 Function Keys



F1 – F10

Ten user-defined function keys; please refer to the [RMC-220 Function Keys section](#) for more details



Stream

Start streaming the live video program to the Internet



Capture

Record the current live video program and save automatically to the hard disk.



Still/Grab

Capture a frame of video and save automatically to the hard disk.

2.5.7 Keyboard Backlight

The RMC-220 allows the user to manually adjust the keyboard backlight. The steps are outlined as follows:

1. Press the knob located below DSK1 key once and the DSK1 key will flash green

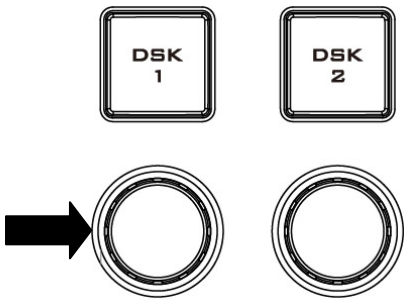

2. Rotate the knob right to enhance and left to dim
3. Press the knob again to turn off this feature

2.5.8 Dimensions

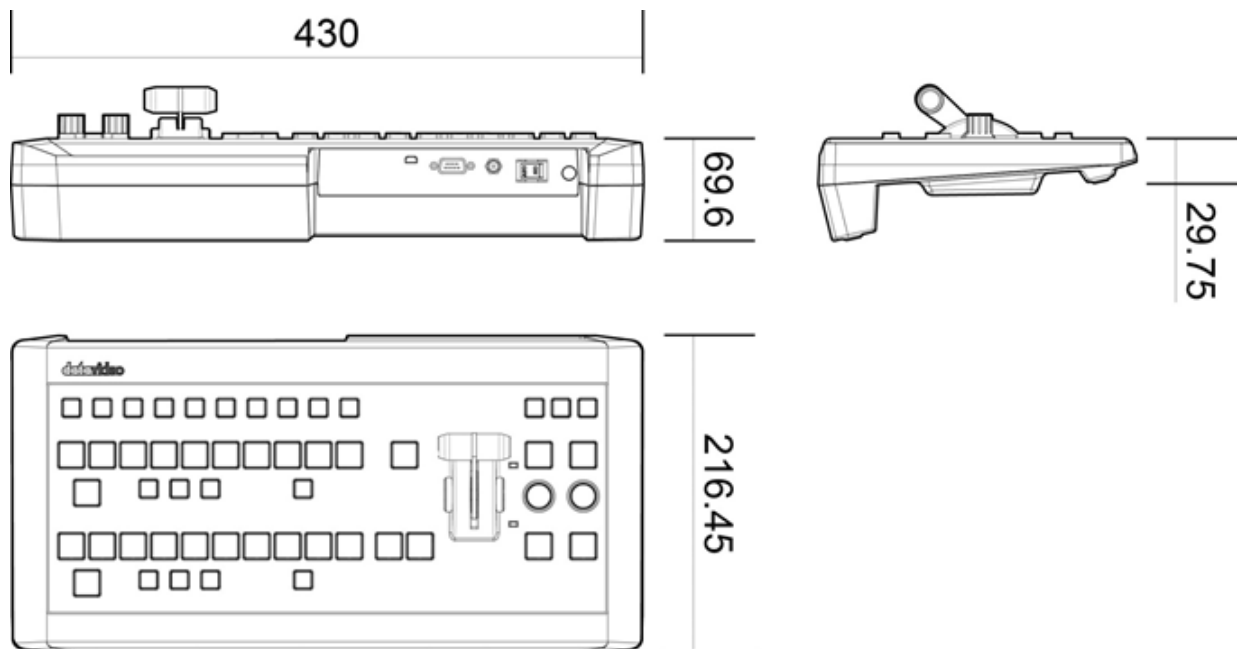

All measurements in millimetres (mm)

2.5.9 Specifications

Communication Interface	RS-232
Baud Rate	38400 ODD
Power	DC12V ± 25%
Power Consumption	5W

Working Temperature	0°C~ +40°C
Storage Temperature	-20°C~ +60°C
Relative Humidity	≤ 90% (non-condensation)
Dimensions	Refer to Page 10
Net Weight	1.28Kg
Accessories	RS-232 Transmission Cable DC In Power Adaptor

Chapter 3 Starting TVS-1200 Software

1. Connect power cord, keyboard, mouse, and RMC-220 to TVS-1200.
2. Connect one or multiple monitors to TVS-1200 via HDMI, DVI and Display Port.
3. Press the power button to boot the TVS-1200 hardware system. Power button is located on the right of the red reset button; please refer to the [Connections Section](#) for the appearance of the power button.
4. Important: Please ignore everything during the system boot-up process, which can take up to approximately one minute, and you will be automatically directed to the TVS-1200 start-up page. For more information, please refer to the [System Recovery](#) section.
5. On the start-up page, seven options are available for the user to choose:
 - a. Production live
 - b. STILL TEXT edit
 - c. VIRTUALSET maker
 - d. RSS
 - e. VIRTUALSET shop
 - f. SHUTDOWN
 - g. Configuration

with details of which outlined in the subsections that follow.



Start-up Screen

3.1 Production Live

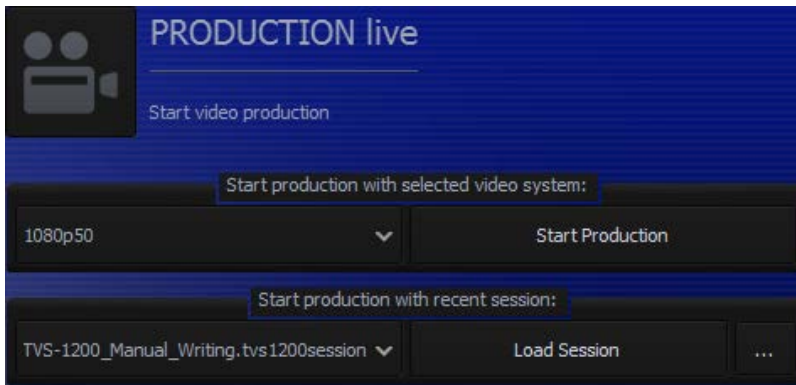

Start a new production by first selecting an appropriate video format. Supported Video formats are 1080i60 / 59.94 / 50, 720p60 / 59.94 / 50, and 1080p60 / 59.94 / 50 / 30 / 29.97 / 25. Click on “Start Production” button to start a new production. The user is also allowed to load previously saved production. Choose a saved session from the pull-down menu as shown below and click on the “Load Session” button to load previously saved production. You can also browse the hard drive to load previously saved sessions by clicking on the button .

3.2 Still Text Edit

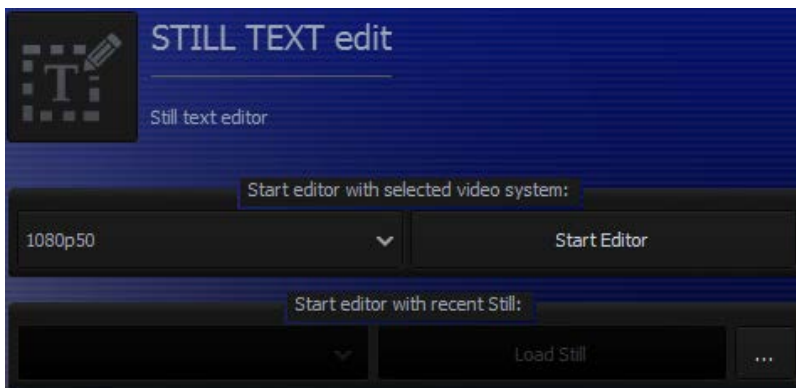

The user can also open **still text editor** from start-up screen. Select a proper resolution first from the pull-down menu and click on the “Start Editor” button to open the still text editor. The “Start editor with recent Still” section allows the user to open and edit previously saved files by either selecting from a pull-down menu or browsing the hard drive.

3.3 VIRTUALSET Maker

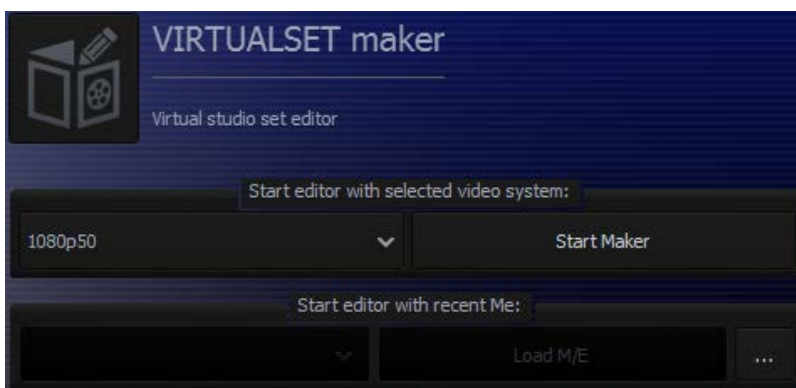

VIRTUALSET maker is designed for the user to edit and make their own virtualset. Again, select a proper resolution first from the pull-down menu and click on the “Start Editor” button to open the virtualset editor.

The Virtualset Maker can also be used as a standalone application on the PC, and may be downloaded from <http://www.datavideo.com/TVS-Virtualsetmaker>. The PC needs to meet the minimum system requirements as described below:

- CPU: i3 Processor or faster
- Memory: 4GB RAM
- Graphic Card: GPU with DirectX 11
- Operating System: Windows 7 (64 bits) or above
- Monitor resolution of 1680 x 1050 or higher

3.4 Rich Site Summary (RSS)

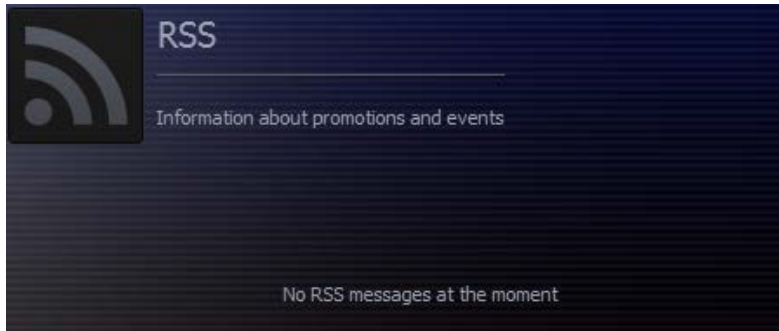

The **RSS feature** allows Datavideo to publish updated information to the user. The information can be in the form of blog entries, news headlines, audio or video.

3.5 VIRTUALSET Shop

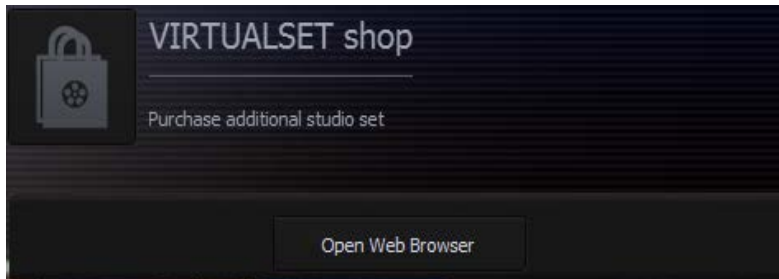

If the user would like to expedite production and avoid the hassles of creating their own virtual background, simply visit the VIRTUALSET shop to download currently available studio sets by clicking on the “Open Web Browser” button.

3.6 Configuration

Configuration offers the user four basic functions: language selection, firmware update, free virtualset download and system summary.

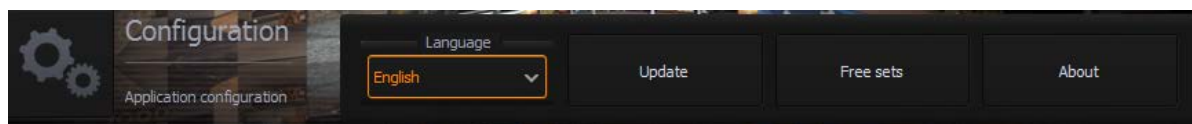

Language: A pull-down menu allowing the user to choose a desired language from English, Simplified Chinese, Traditional Chinese and Japanese.

Update: When clicked, the following window appears while the system searches for firmware update

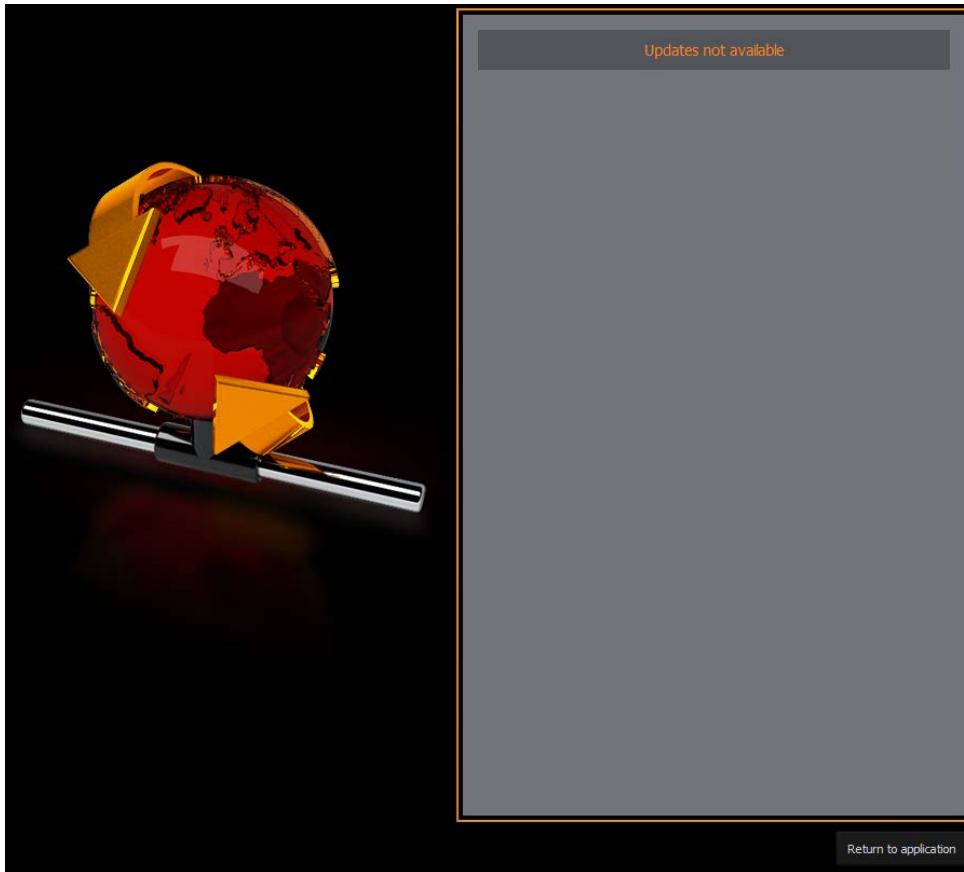

Free sets: Click on this button and follow the instructions below to download free sets from the Internet

How to download free sets if you already have an account on

<http://www.datavideovirtualset.com/?>

- On the TVS-1200 main screen, select configuration then click the “Free Sets”
- Enter your email address then click “download free sets”
- Please be patient while downloading
- After free sets are downloaded successfully, click “OK” to go back to main screen

How to download free sets if you DO NOT have an account on

<http://www.datavideovirtualset.com/?>

- On the TVS-1200 main screen, select configuration then click the “Free Sets”
- Enter your registration info then click “Register”
- Please be patient while downloading
- After free sets are downloaded successfully, click “OK” to go back to main screen



Or you can also scan the QR Code on the left to take you to a video tutorial showing you how you can download free sets from the Internet.

About: A pop-up window will appear, displaying information such as EULA, Version number, and Serial Number



3.7 Shutdown

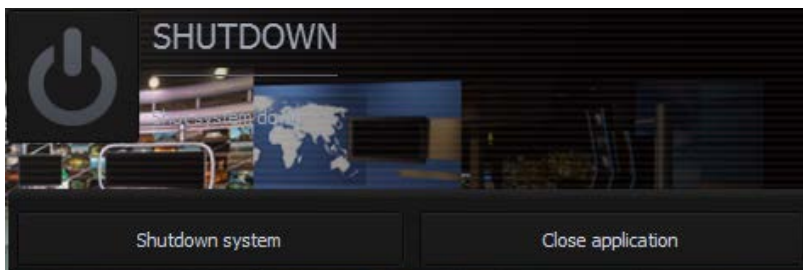

To exit the startup panel, the user can simply click on the “Close application” button or the “Shutdown system” button to shut down the system.

Note: A popup warning dialogue box will appear as shown below after you click on the “Close application” button.



Chapter 4 VIRTUALSET Maker

VirtualSet Maker is a built-in tool in TVS-1200, a computer-based 2D trackless Virtual Studio System. It provides the user with the capability of designing customized virtual sets, which comprise layers of graphic files. New layers can be added, the order of layers can be reshuffled, and existing layers can be hidden or removed. In addition, the individual layer orientation can be altered as you like.



The final virtualset composition can be saved in a special file format readily available for use in the Production Live Module.

In addition, the Virtualset Maker can be used as a standalone application so that it can be installed separately and used on your PC just like any other standard software. The software may be downloaded from <http://www.datavideo.com/TVS-Virtualsetmaker>. The PC needs to meet the minimum system requirements as described below:

- CPU: i3 Processor or faster
- Memory: 4GB RAM
- Graphic Card: GPU with DirectX 11
- Operating System: Windows 7 (64 bits) or above
- Monitor resolution of 1680 x 1050 or higher

After Virtualset Maker is installed on your PC, simply click on the VIRTUALSET maker desktop icon to open the VIRTUALSET maker. Before you start the software, please make sure your monitor resolution is set to 1920x1080p.

4.1 Features

- Customized design of virtualsets
- Two-talent virtualset design
- Multiple TV screens with configurable aspect ratio other than 16:9
- Stacking of layers of graphic files
- Layer editing such as add a new layer, change the order of layers, hide existing layers, or remove an undesired layer
- Change layer orientation such as zoom, position, and rotation along x, y and z-axis
- Undo and redo functions with limited history of operations
- Virtualset editing using cut, copy and paste
- .dvsx virtualset file format readily available for use in the Production Live Module of TVS-1200
- Available in four different languages: English, Simplified Chinese, Traditional Chinese and Japanese
- Three talent shot settings: full body, half body or desk shot
- Editing of the virtualsets downloaded from Datavideo's virtual set database (<http://www.datavideovirtualset.com/>)

4.2 Getting Started

On the desktop of TVS-1200 Virtual Studio System, double click the TVS-1200 icon on the desktop to start the system and bring up the startup page as shown below.

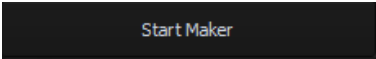

Start-up Screen

Locate and click on  to open VIRTUALSET Maker. However, before you start, select a proper resolution first from the pull-down menu on the left of the "Start Maker" button first. You can also select and load existing virtualset file from the hard disk. The VIRTUALSET Maker window should open as shown below.



VIRTUALSET Maker

Pane 1 is the preview area that allows you to view all modifications made to the virtualset. Pane 2 contains the order of all layers, where you can define their relationships in a virtualset. Pane 3 is the controller part, which are tools for zoom, rotation and file change of the layers.

4.3 VirtualSet Maker Tour

On the menu bar of Virtualset Maker, you will find four options: File, Edit, Configuration and Help. The table below lists all sub-options and their corresponding descriptions.

File	New	Opens a new file
	Load	Loads an existing file
	Save	Saves the current design
	Save as	Save the design in a different name (Overwrite protection function is available)
	Exit	Exits the Virtualset Maker
Edit	Undo	Erases the last change done to the virtualset
	Redo	Reverses the undo command
Configuration	Language	English Simplified Chinese Traditional Chinese Japanese
	Talent Type	Full – Full body shot Desk – Desk shot Middle – Half body shot Custom – Custom shot Customize – Click to search the custom shot
	Talent 2 Type	Full – Full body shot Desk – Desk shot Middle – Half body shot Custom – Custom shot Customize – Click to search the custom shot
Help	About	End User License Agreement (EULA)

First of all, open a new file in VIRTUALSET maker and find the layers pane on the right of the window. The layers pane (pane 2) offers the user four options:

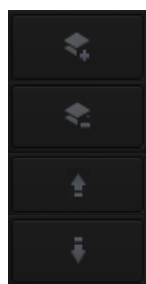

- Create: Add graphic layers
- Delete: Remove graphic layers
- Raise: Move a graphic layer up a layer
- Lower: Move a graphic layer down a layer

To start editing, at the top-left corner of the layers pane, locate the create icon  and click on it to select the layers. A dialogue box “Select layer type” will open, on which the user will be able to find five layer types .

- Source A (Talent): Camera shot layer
- Source B (Screen): A secondary screen embedded in virtualset
- Source C (Talent 2) A second camera shot layer
- Static Layer: Logo layer (adjustable images)
- Studio Layer: Graphic layers (image will be stretched to the current display resolution)

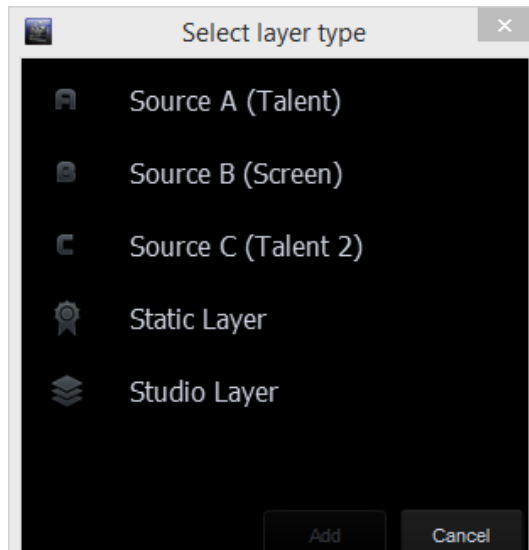

Please note that the suggested resolution of the studio layer is 2880 x 1620 (16:9). This is the standard virtualset resolution in TVS-1200. You can of course use other resolutions but you will need to fine-tune your image later.

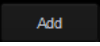
Select “Studio Layer” to browse the hard disk and click on the “Add” button  to import an image file to VIRTUALSET maker from the disk. Browse the disk for the files and single clicking on the file name allows you to preview the image in the preview area.

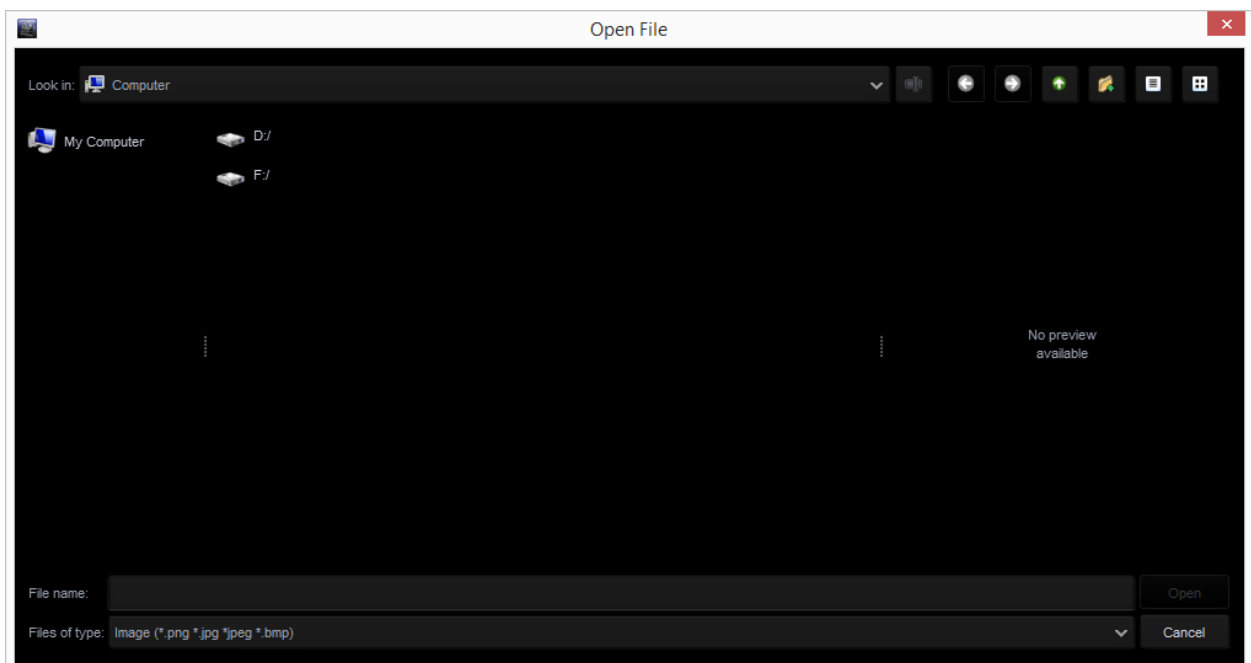

After the image is imported, you will be able to see two icons, eyes and solo, in the layers pane (pane 2) beside the image thumbnail. Their functions are described below:





Eyes Click to make a particular layer visible in the editor

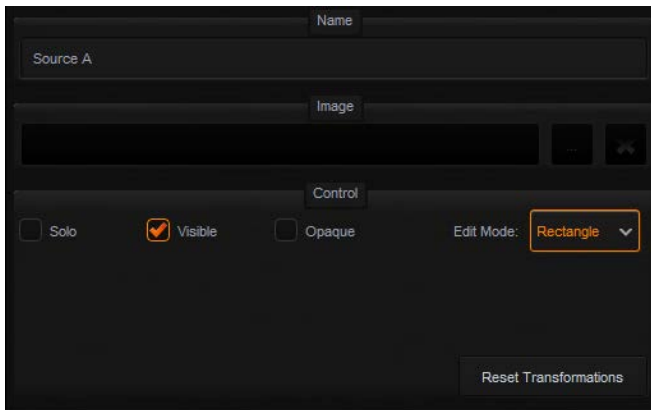

Solo Click on this button to hide all other layers except the selected layer object

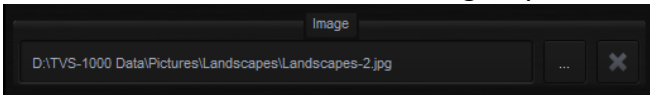

At the bottom left hand corner of Virtualset Maker, there are various options available for the user to manipulate the layers (While Studio layer is selected, some image layer options will be disabled).

Name	Name of the selected layer
Image	<p>Path of the selected file for static logo layer and studio layer</p>  <p>Click  to browse the hard disk for image files</p> <p>Click  to remove the image from the layer</p>
Solo	Checking this option hides all other layers except the selected layer.
Visible	Unchecking this option hides the selected layer.
Opaque	This option is only available for the talent layer and checking this option blackens the background of the selected talent layer.
Edit Mode	<p>This option is enabled once either one of the talent layer, screen layer or static logo layer is selected.</p> <p>Points Mode allows the user to do all kinds of transformation on the selected layer, i.e. the logo, talent rectangle and the screen rectangle can be adjusted to various shapes as shown in the diagram below.</p>

	 <p>In Rectangle Mode, the user is only allowed to adjust the size of the rectangle without changing the shape.</p>
<p>Reset Transformation</p>	<p>Click on “Reset Transformation” will restore the selected layer to its default shape and size.</p>

Next, import a logo (static layer) from the disk and place it above the studio layer.



VIRTUALSET maker gives the user the capability to manipulate the layer orientation. Once the logo is imported, you will see that the controllers in pane 3 are enabled. The example below illustrates how you can zoom, rotate and position a “datavideo” logo using the five controllers outlined as follows. The goal is to pave the studio layer with the datavideo logo.

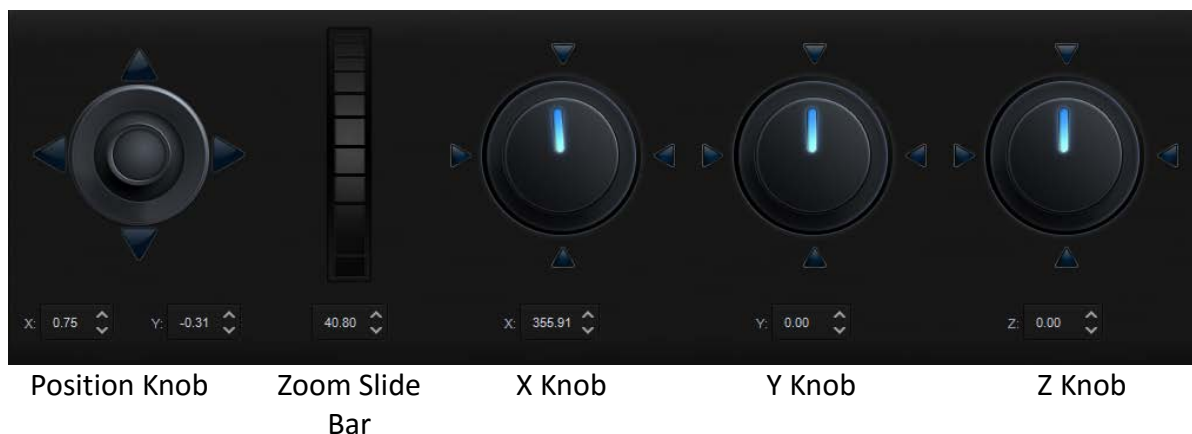

The logo can be flipped along the x-axis.



The logo can be flipped along the y-axis.



The user can also tilt the logo sideways.



Finally, use the position knob to move the datavideo logo to the desired position and the zoom slide bar to fine-tune the logo to the appropriate size. The diagram below shows you the final work with the floor covered with datavideo logo.



After all graphic layers are arranged in place, import the screen layer (Source B), which will be shown in VIRTUALSET maker as a green rectangular box.

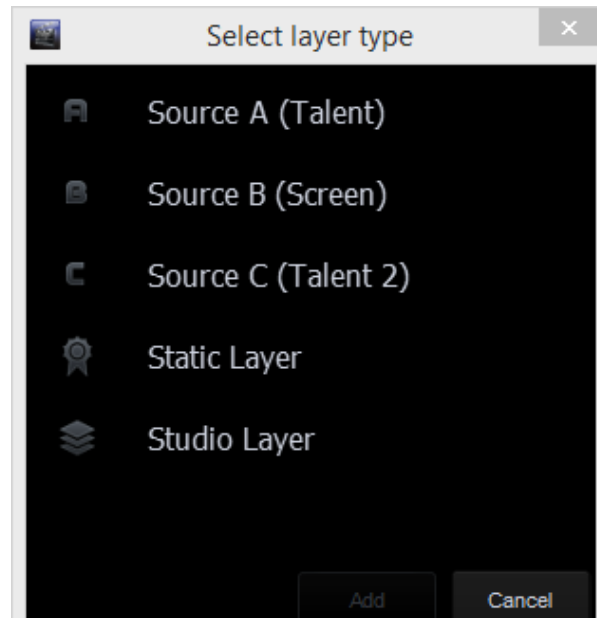

Screen area is where the video or picture are placed after program starts. Adjust and move the green rectangular screen to the respective desired size and position using the controllers in pane 3. In addition, the screen size and shape can also be adjusted by pulling or dragging the four corners.



Please note that the Virtualset Maker allows the user place up to six screens on the studio layer. The diagram below depicts a virtualset with two screens.

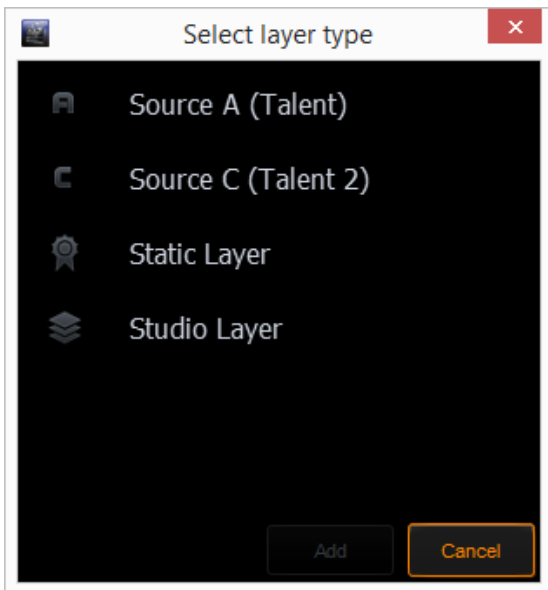

If you have already placed all six layers on the studio layer, the screen option (Source B) will then no longer be shown on the “Select Layer Type” dialogue box.

The last layer to be imported to the virtualset will be the talent layer (Source A or C). Virtualset Maker allows the user to place two talent layers on the studio layer. However, Sources A and C are one-time selections so they will not be shown in the “Select Layer Type” dialogue box after they are selected.

Please note:

TVS-1000 supports only one talent layer (Source A), so even if your virtualset is designed for the two-talent scenario (Source A and Source C), only one talent will appear on the TVS-1000 system.

TVS-1200 supports two talent layers (Source A and Source C), but if your virtualset is designed for the one-talent scenario (Source A), only one talent will appear on the TVS-1200 system.

After importing the talent layer, the user will find that there is a white frame enclosing the talent. This is the confinement defined for talent movement, in other words, it is the coverage of a camera lens during actual shooting.



After everything is in place, fine-tune your talent layer size and move the talent layer to the desired position.

Finally, save your virtualset on the disk, and please remember that checking “Mark set as not writable” applies overwrite protection to the set.

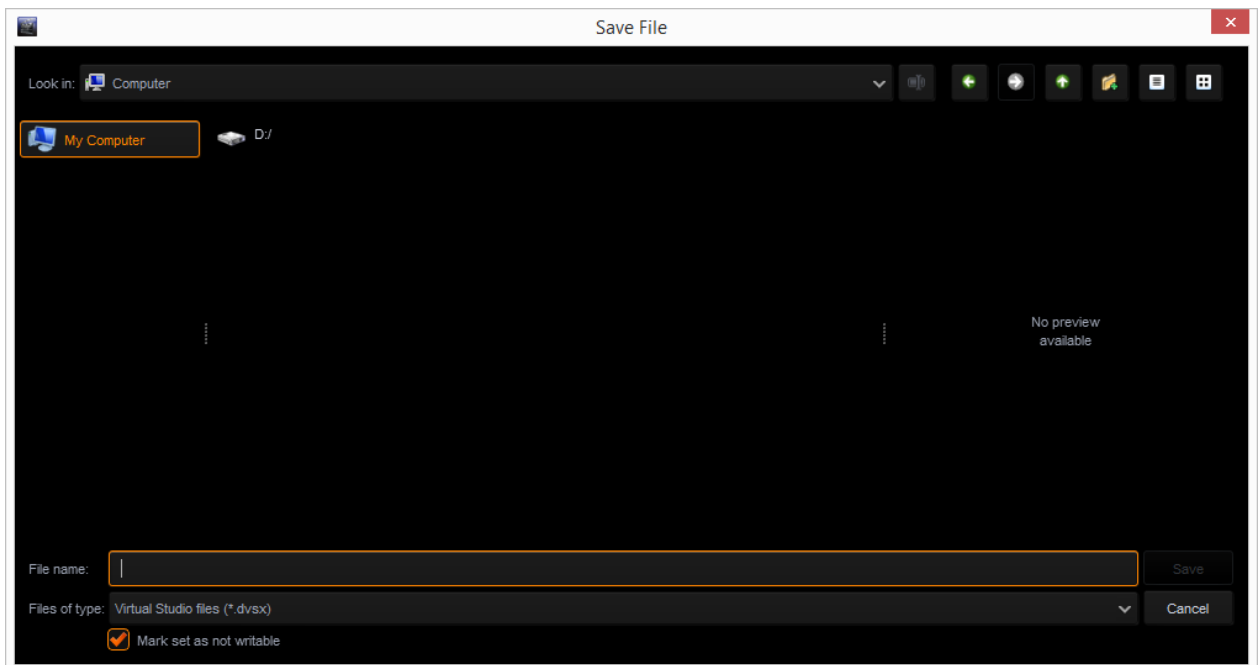

After the virtualset is saved, close VIRTUALSET Maker, and import the virtualset to the Production Live Module to start your own virtual studio tour.

Chapter 5 Production Live Screen

After entering the production live option, the production screen will appear as illustrated in the diagram below. The production screen can generally be divided into five areas:

1. Tool Bar
2. Multi-View Screens
3. Switcher-like Buttons
4. Virtual Background Editing
5. File Management



5.1 Tool Bar

There are three options on the tool bar: File, Configuration and Help.

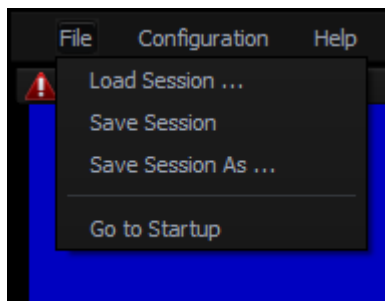

File

- Load Session: Opens previously saved production
- Save Session: Saves the current production
- Save Session As: Saves the current production with a different name
- Go to Startup: Takes the user to startup screen

Configuration – Layout

Screen adjustment where in this option the user is allowed to select the number of screens to be used.

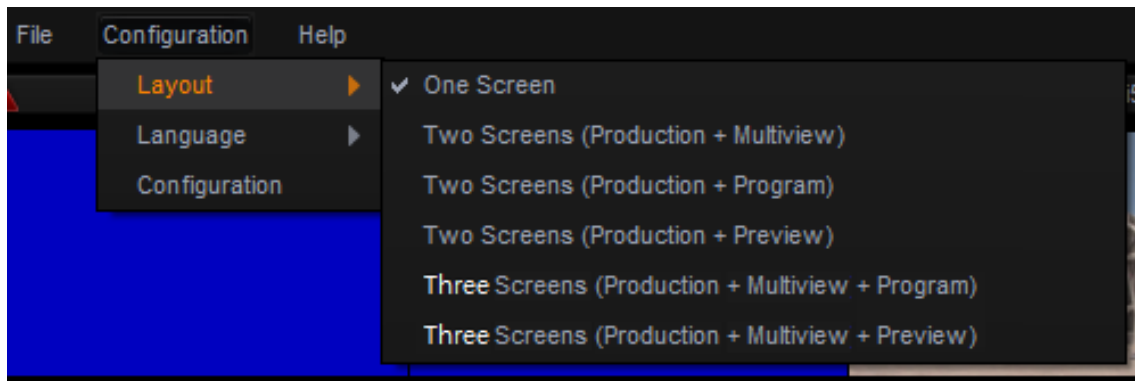

Configuration – Language

The user is allowed to select among three languages listed as follows:

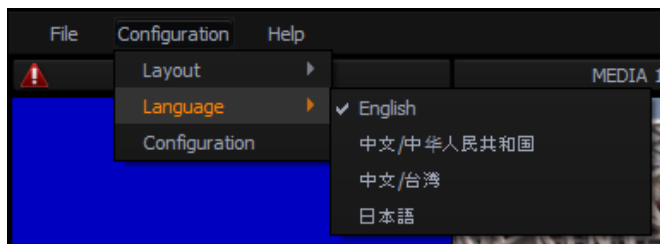

- English
- Simplified Chinese
- Traditional Chinese
- Japanese

Help

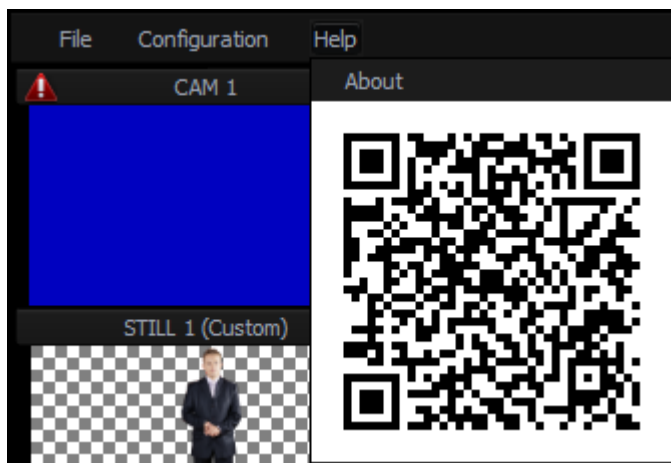

- About: Clicking About displays information such as EULA, Version number, and Serial Number
- QR Code: Scan the QR code to download the TVS-1200 User Manual

5.2 Multi-View Area

In the multi-view area, the user is able to view the camera source and other multiple multimedia file sources on the left-hand side of the area. There are two screens on the right-hand side: PREVIEW and PROGRAMME.

- PREVIEW – presentation of the next element prepared for broadcast
- PROGRAMME – presentation of the current programme broadcast (system output)



Details of each individual element are described in the table below.

1	Cam 1	SDI Camera preview window 1
2	Cam 2	SDI Camera preview window 2
3	Media 1	Video clip 1 from hard disk drive
4	Media 2	Video clip 2 from hard disk drive
5	Still 1	Preview window for picture 1
6	Still 2	Preview window for picture 2
7	Text 1	Preview window for the still text source 1
8	Text 2	Preview window for the still text source 2
9	Preview	Preview source window
10	Program	Program source window
11	Stream	Stream the program video to the Internet
12	Capture	Record the program video to PC's hard disk
13	Still / Grab	Capture still picture on the program screen
14	Audio Meters / Volume Control	Audio meters display the output audio signal strength & volume control adjusts the output audio signal strength

5.3 Program and Preview Rows & Function Settings

The central part of the screen of **Production Live** is occupied by the Production Switcher. The Production Switcher panel consists of two rows of buttons and a block of executive buttons. It is used to send selected content on air and prepare the next material for broadcasting.



Program and Preview Rows are production switcher style buttons. The user is able to switch between different sources displayed on the Preview and Program screens by clicking on the corresponding buttons.



5.3.1 10-input Main Switcher

- 2 x CAM – enables two camera sources and the chroma and luma keying functions can be applied to the signals on this channel.
- 4 x M/E – Four virtual studio background inputs
- 2 x Media – Two video programs saved on local hard disk
- 2 x Stills – Two static pictures saved on local hard disk

The top row of buttons, PGM, indicates the image that is currently broadcasted. The selected broadcast source button is illuminated in red.

The lower row of buttons, PVW, indicates the source of image to be broadcasted next. The active button is illuminated in green. The material choice is seen in the PREVIEW window.

After editing and selecting the desired program source, the next step is to use function keys to stream the program, apply transition effect, place logo on the program view, add animation to the program and etc. Brief descriptions of function keys are outlined below.

5.3.2 Switching between Preview and Program Views

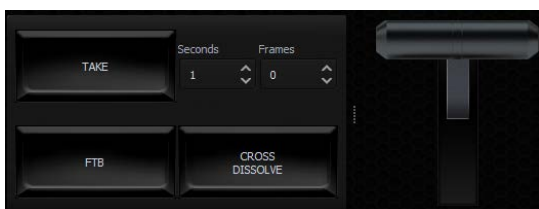

- TAKE: Click to switch between Program and Preview with a transition effect
- FTB: A Fade-to-Black is the effect which fades the Program view gradually to black, or when a picture gradually appears on screen; click on the button to apply the FTB effect to Program output
- Cross Dissolve: A dissolve is a gradual transition from one image to another; click on the button to apply the effect.
- T-Bar: Shift up and down to switch between Preview and Program.
- Transition time will be based on Time and Frame presets in seconds.

5.3.3 Downstream Keys

Next to the 10-input main switcher is the downstream key (DSK) block. It can be used to add images or text to the broadcast signal. DSK signal may come from any virtual player that displays media (1 or 2), bitmaps (1 or 2), or text (1 or 2). It may also come from the camera inputs. For the DSK function to operate properly, the media provided to DSK must contain transparent areas. In this way, they will be overlaid on the main signal. Media without transparent areas is not recommended to be used in DSK as they would completely cover the broadcast image with their contents.

There are two DSK keys available for the user. Follow the following procedure to display DSK on the Program view:

- Switch on one of the DSK buttons;
- DSK button is illuminated in green;
- Select the source from the list below;
- The text is ready to be broadcasted;
- The text preview is shown in PREVIEW;
- The Placement button can optionally be used for changing the size or position of the text on the Preview screen (**Note:** change of the text position is impossible if the text is already on air);
- The text can be put on air gradually (using the Fade button) or abruptly (using the Cut button) and disappears from the Preview Screen;
- The operation of the Fade and Cut buttons is independent of the Production Switcher TAKE button;
- If the text is on air, the colour of the DSK button changes to red;
- To remove the text from the air, click on the Fade or Cut button once again;
- When the text is taken off air, the DSK button colour returns to green and the text will now appear in PREVIEW screen again.

- Text 1
- Text 2
- Media 1
- Media 2
- Still 1
- Still 2
- Camera 1
- Camera 2



To configure position and size of the downstream key, click on the placement button to open the window shown below.



- Joystick: Logo positioning
- Center Roller: Logo scaling
- Adjustment Knob: Logo rotation (Still Text and Picture only)

After the logo to be placed on the program view is properly configured, the next step is to place the logo on the program view. Click on CUT/Fade buttons to switch the key between Preview and Program screens and the button will turn red. The two downstream keys are designed in such a way that the user is allowed to simultaneously place two downstream keys on the program view.

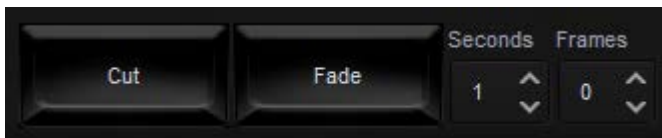

- Cut: Instantaneous switching between Preview and Program screens
- Fade: Gradual switching between Preview and Program; fade time will be based on Time and Frame presets in seconds.

5.4 Virtual Background Editing

In Virtual Background editing, each mix effect (M/E) behaves like a real camera. In other words, selection of an M/E is like selecting a camera in a multi-camera environment. Each phase corresponds to a virtual camera position. The user can switch between phases by clicking on phase windows, which is similar to the “cut transition” effect on a switcher.

In the Virtual Background Editing area, the user is provided with multiple mix effects to perform advanced editing of up to a maximum of four virtual studios (M/E1 – M/E4). In each of the M/E editing, there are three phases available, allowing the user to zoom in to the talent with each phase corresponding to a user-defined zoom distance. Please refer to the diagram below for diagrammatic illustration.

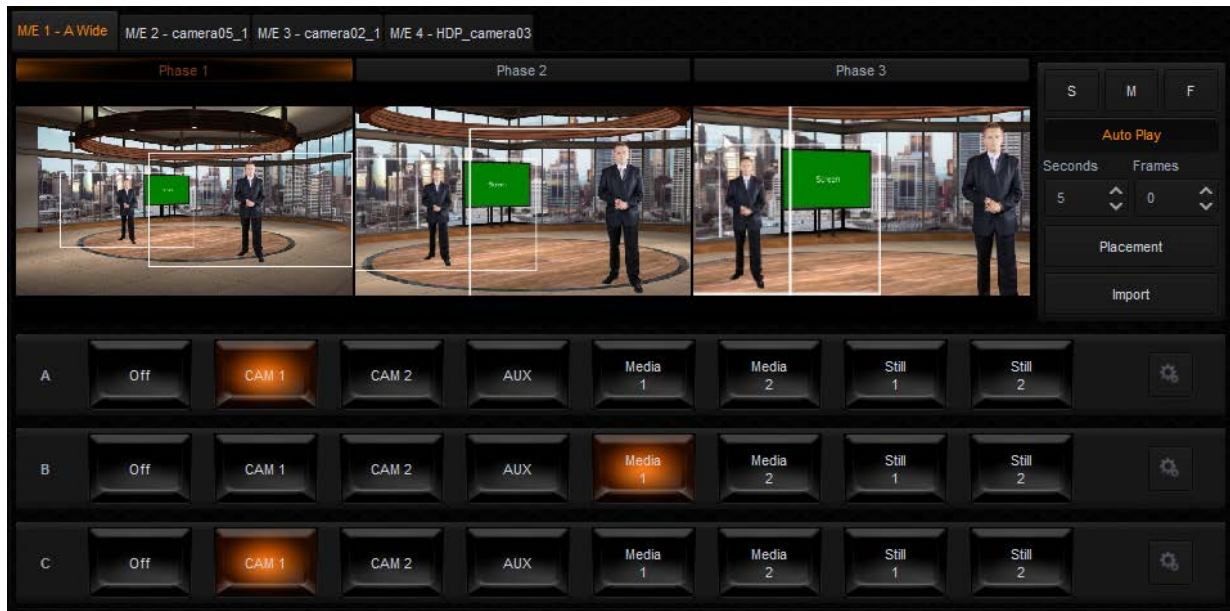

The virtual studio configuration panel is located in the bottom left-hand corner of the screen. Three rows of buttons located below the three phase windows serve the purpose of allowing the user to select talent material source and plasma TV material source. As depicted in the diagram above, row A is for talent material source selection and row B is for plasma TV material source selection. Row C is for second talent material source selection and will only be activated if the two-talent virtualset is used. In the example above, row C is disabled in the one-talent scenario. The sources can be live show from Camera 1 or 2, Media 1 or 2, Still 1 or 2, or even Black if necessary. The selected source button is illuminated in amber.

Row A and Row C are usually talent images from CAM sources. The keying filter is overlaid on this source. The keying filter overlay removes the single-colour background on which the talent is shot (e.g. green). The other signal source, Row B, may be a video or a still image. It is usually displayed on a virtual screen, which is designed as part of the studio set. However, it all depends on the studio design. Signals can be used differently in every studio. Because of this, signals are denoted in a universal way, as A and B, in the studio configuration panel.

After selecting the talent and plasma TV material sources, the next step is to customize your program. There are three features that give the user the ability to customize their program: import, placement and auto play. Import allows the user to select their preferred virtual background. Placement gives the user the flexibility of positioning the selected virtual background. Auto Play generates the animated PTZ transition effect.

5.4.1 Import

The user may import virtual set background from the hard disk drive (HDD). Click on the **Import** button to open a window that displays a list of directories containing virtualset files. Preview of the selected virtualset is available on the right of the directories listing window. Choose the desired dvsx file to the selected M/E bin. Click on M/E1-4 tabs to view the corresponding loaded virtual studios on Preview window of the Multi-View Area.

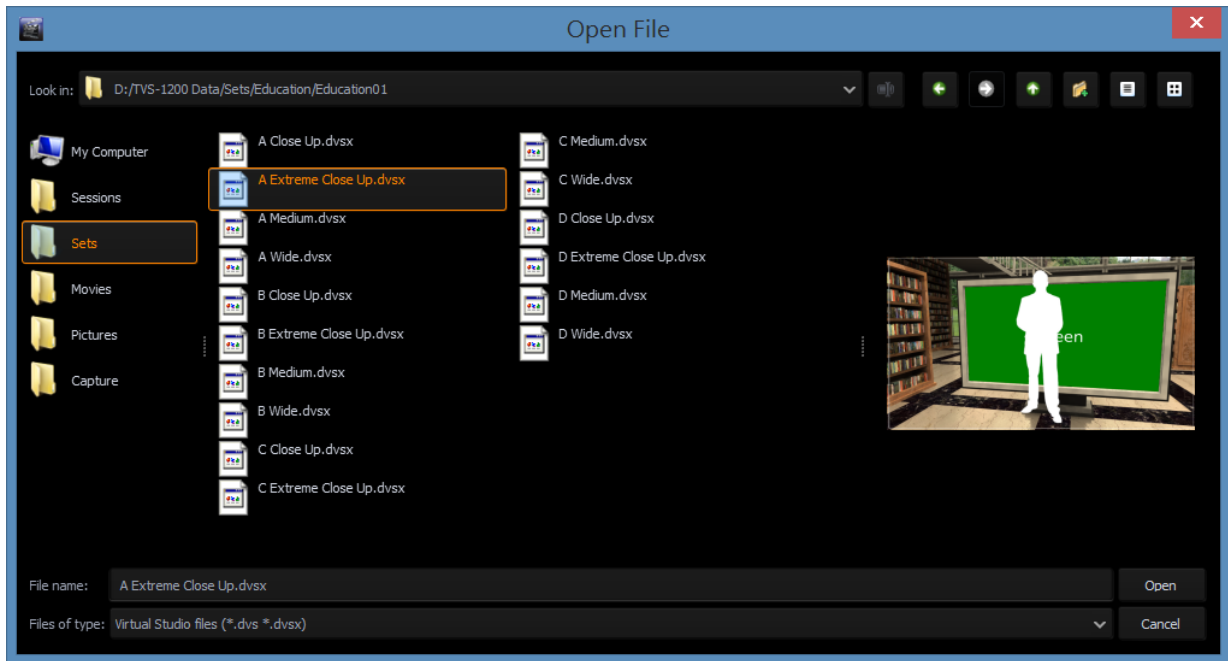

File Location: D:/TVS-1200 Data/Sets/

5.4.2 Placement

Phase is defined as the virtual camera position in a virtual studio. Each virtual scene (M/E1 – M/E4) can be assigned three phases (phase 1 – 3). Click on any of the three phase windows to configure the image phase settings. The current phase is highlighted with an orange bar above the preview window as shown in the diagram below.



Placement function allows the user to customize the phases, i.e. change the camera position manually. Possible virtual camera movements are Pan, Tilt and Zoom. To set the phase, click on the “Placement” button to open the “**Placement Configuration Window**” as shown in the diagram below, which allows the user to select desired PAN, TILT and ZOOM values.



Locate the control panel on the right of the “**Placement Configuration Window**”. X and Y are the adjustable coordinates. The user can use the joystick to configure the PAN and TILT settings. The zoom slide bar on the right adjusts the zoom in/out values accordingly. The user can also use the mouse scroll wheel to adjust the zoom in/out values.

An additional button, **Default**, enables restoration of the default settings.

The preview window is on the left of the “**Placement Configuration Window**”, allowing the user to preview the changes. Click the “Close” button to shut down the “**Placement Configuration Window**” after you have configured the desired placement settings.



5.4.3 Auto Play

Auto Play generates the animated PTZ transition effect. If the AutoPlay function is switched on, the camera movement is smooth, animated. The transition time is adjusted by controls located on the right of the phase previews (Time, Frame). If the **Auto Play** button is turned off, the camera position is switched ‘sharply’ (cut effect without animation). To make things easier, three default transition duration times between phases have been defined: F (1 s), M (3 s), S (5 s). For every newly imported studio, default phase settings are defined: the first phase has zero zoom (0%), the second phase has a 50% zoom, and the third phase has 100% of the maximum zoom.

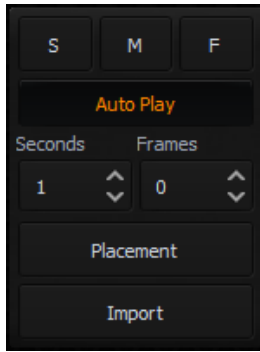

S: Slow speed (5 seconds by default)

M: Medium speed (3 seconds by default)

F: Fast speed (1 second by default)

The user can customize the transition time by clicking the up-down arrows of the time and frame settings. Click on the Auto Play button (font will turn amber) to activate the desired animated transition after configuration.



Finally, click on  located on the right of the rows of Source A, Source B and Source C to open a configuration window that allows the user to adjust the size and position of the talent as well as the view on plasma TV. The settings are remembered by the program until a new view is loaded. To be remembered, they can be saved in the session file. The configuration window is shown below.



- Joystick: Talent positioning
- Center Roller: Talent scaling
- Adjustment Knob: Talent rotation

Please note that movement of the talent is limited within the white rectangular box as depicted in the diagram below.



All settings of a studio (selected sources, source positions, camera phases) can be stored for later use by saving them in a session file. The settings saved in this way can be loaded by opening the session file upon starting the Production Live module.

5.5 File Management

TVS-1200 allows the user to apply videos and still images to the program window. The file management system is designed to serve this purpose by allowing the user to do all the preparation work before the broadcast. It is also known as Media Bin, which is divided into tabs as shown in the diagram below. Shortcuts to the media files are placed in the appropriate tabs. This facilitates the use of media during live production.

The bin has six tabs for files assigned to a given player. There are two tabs for video files (Media1, Media2), two for bitmaps (Still1, Still2), and for text (Text1, Text2). TVS-1200 supports the use of media in multiple formats. It has also integrated support for many codecs to play video files.

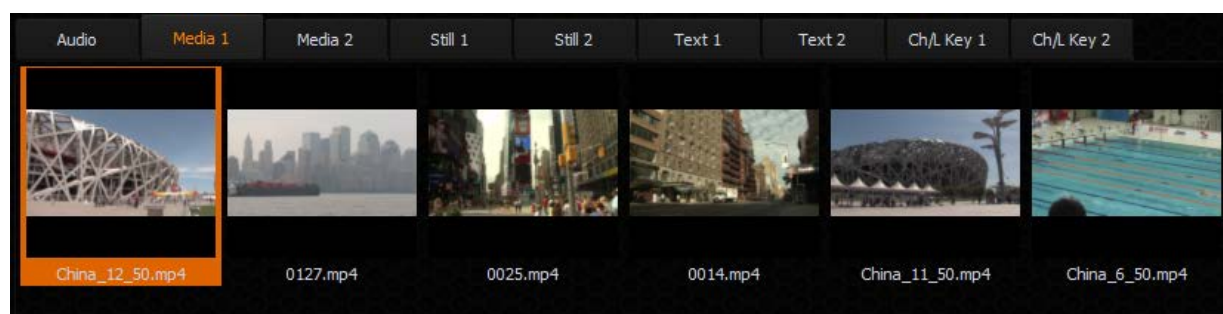

In each specific tab, the user can also divide the content (files) into five categories (maximum). This is done by means of sections (designated 1 to 5). The sections can be used to keep files in order, for specific activities.

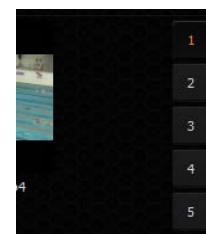

The use of media requires two actions:

- the addition of a file to the bin;
- loading the medium into a virtual player.

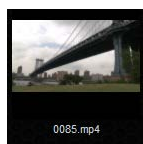

For each file added to the Media Bin, an icon is automatically generated. This enables the preview of the file content. Within a given tab, icons can be sorted using drag and drop. For files with the alpha channel (with transparency), a

preview is displayed showing transparency against a background of a gray and white grid.





To add a file to the bin, a tab (or a subtab within a tab) has to be selected. After that, either click on the  add file button or double click on an empty space within the selected tab of the bin, and a typical file browsing window will be opened.

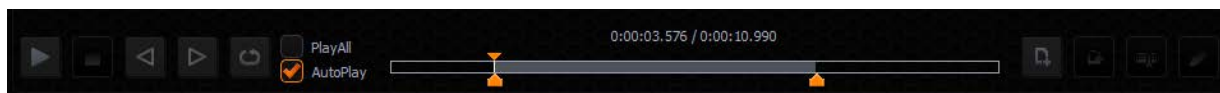

Next to the add file button, there is a  file removal button. It removes the selected file from the bin. If the file being removed has already been loaded into a player, the user will be prompted for confirmation. After the removal of a file (media), the preview for the corresponding player shows a blue background.

Please note that no operations on files in the Media Bin change files on the hard disk. File removal or file name changes only affect shortcuts to the files on the tabs. It is also possible to add a file to the same tab or to different tabs multiple times. The user can also change the names of files (shortcuts) by clicking the file name change button  next to the file removal button, and the same file can be used with different names.

To load the medium into a virtual player, double click on the file with the mouse. The medium will be played (MEDIA1 or MEDIA2, STILL1 or STILL2, TEXT1 or TEXT2) and can be used directly in a live program.



Buttons in the lower part of the Media Bin are used to control the file played in the player. The available functions are: Play , Pause , Stop , and Loop  (Loop is on by default). The playback progress bar, information on the video length and the current playback position are also shown. Right after being double clicked in the bin, a video is loaded into a virtual player and begins to be played in a loop. If the loop playback is switched off, the video will stop on the last frame. Pressing the Stop button causes playback to return to the first frame.

The Media Bin also has mark-in and mark-out features that allow the user to set a start point and an end point before playback of a video clip. The user can simply move the cursor on the playback progress bar and fine tune the cursor position frame by frame by clicking the forward  and reverse  buttons.

In addition, by checking the PlayAll option and enabling the loop feature, the user is allowing loop playback of the whole media folder. AutoPlay allows the virtual player to play the video clip upon entering the media folder.

NOTE: It is recommended that files should be added to the Media Bin only from a hard disk permanently connected to the workstation. If files from other media need to be used, they should be physically copied to the hard disk and only then added to the Media Bin.

Media 1/2 – As depicted in the diagram below, this is where the video files can be displayed. Click on  to browse the local hard disk for video files. The user is allowed to classify the

selected video files into five categories. Navigate through the categories by clicking on buttons 1 to 5 located on the right of the file display area.

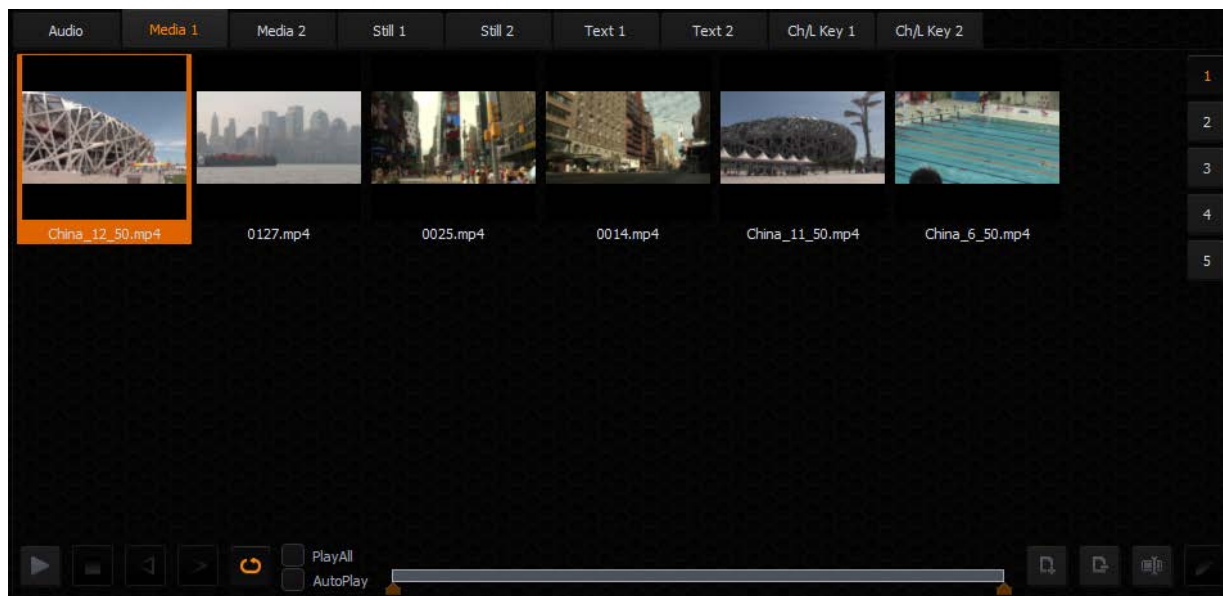

The formats and codecs supported for video files (for media added to the MEDIA1 and MEDIA2 tabs) are:

- H.264/AVCH.264/AVC Smart Render Wrapper
- H.265/HEVC
- MPEG-1/2
- MPEG-2 Smart Render Wrapper
- MPEG-4 P.2 / H.263
- DivX / DivX Plus
- VC-1
- DVCPRO 25/50/HD
- VC-3
- JPEG2000
- MVC/3D
- AVI

Still 1/2 – As depicted in the diagram below, this is where the still picture files can be displayed. Click on  to browse the local hard disk for picture files. Again, the user can classify the selected picture files into five categories. Navigate through the categories by clicking on buttons 1 to 5 located on the right of the file display area.

The formats supported for bitmap files (for media added to the STILL1 and STILL2 tabs):

- JPG
- PNG (with transparency)
- BMP

To perform slideshow of still pictures, enable the “PlayAll” function and then click on the Play button .

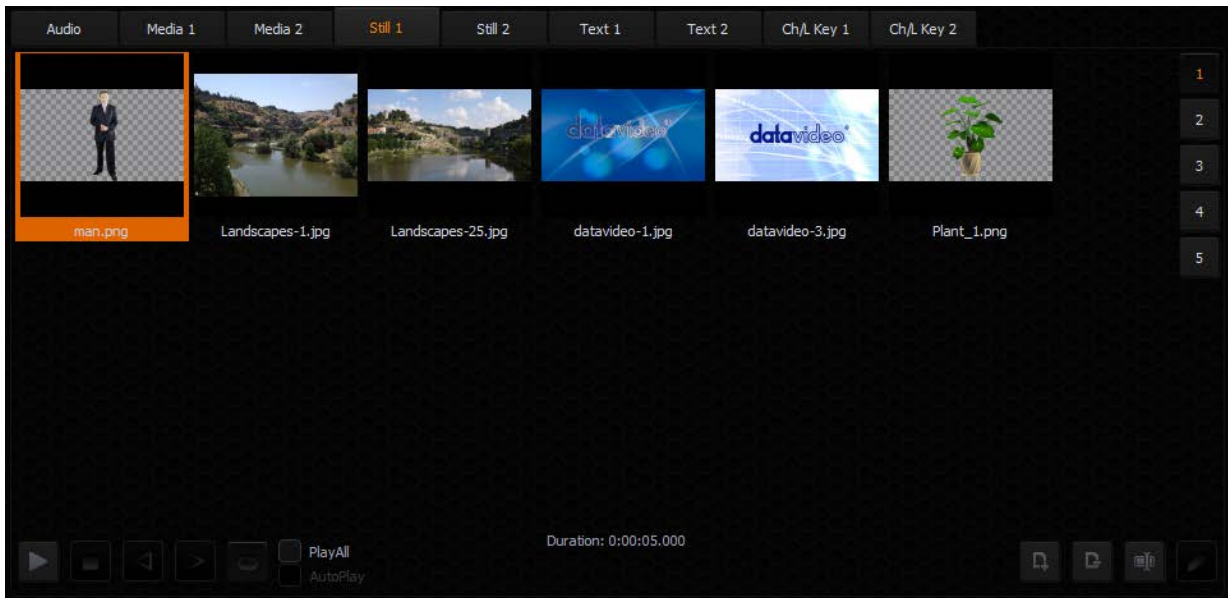

Text 1/2 – As depicted in the diagram below, this is where the still text files can be displayed.

Click on  to browse the local hard disk for still text files. Again, the user can classify the selected still text files into five categories. Navigate through the categories by clicking on buttons 1 to 5 located on the right of the file display area.

The formats supported for bitmap files (for media added to the TEXT1 and TEXT2 tabs) are:

- JPG
- PNG (with transparency)
- BMP
- TVS-1200 STILL (own STILL TEXT edit module)



5.6 Additional Monitor Support

TVS-1200 operates on multiple input and output signals. To ensure better functionality for the preview of the signals, the user may connect additional monitors to the workstation. With a separate monitor, the preview can be larger than the one in Production Live.

Another monitor can be used for Multiview, which is a clear interface presenting the previews available in Production Live.

The following previews are available in Multiview:

- PREVIEW – presentation of the element chosen to be broadcasted next;
- PROGRAM – presentation of the current signal (system output);
- Previews of virtual sets loaded into memory;
- Preview of all media loaded into virtual players;
- Camera preview (one or two, depending on system configuration).

A third monitor may, with suitable configuration, show a full-screen PREVIEW or PROGRAM view. The third monitor can also be used for the mirror output of the talent. Please refer to the section, **Configuration – Layout**, if multiple monitors are connected.

Hence, in order to allow the user to manage multiple monitors, a Monitor Configuration Interface as shown in the diagram below is built into the TVS-1200. To open the interface, simply click “**Configuration**” on the tool bar, select “**Configuration**” option and then click “**Screens**” button.



The user is thus able to shuffle monitor assignments by making selection of the desired display in the pull-down menu. In the example above, only one monitor is connected and by default, only the production module is displayed.

5.6.1 General Display Settings

To configure additional display settings, click on the General tab where the user will find two options, **Image default playback time (sec)** and **Mirror on PGM Monitor** as shown in the diagram below. By checking the option, “Image default playback time (sec)”, the user will then be allowed to set the playback time for slide show of still images. Mirror on PGM Monitor, after enabled, will display a mirrored image of the Program View, i.e., the Program view image is flipped along the y-axis.

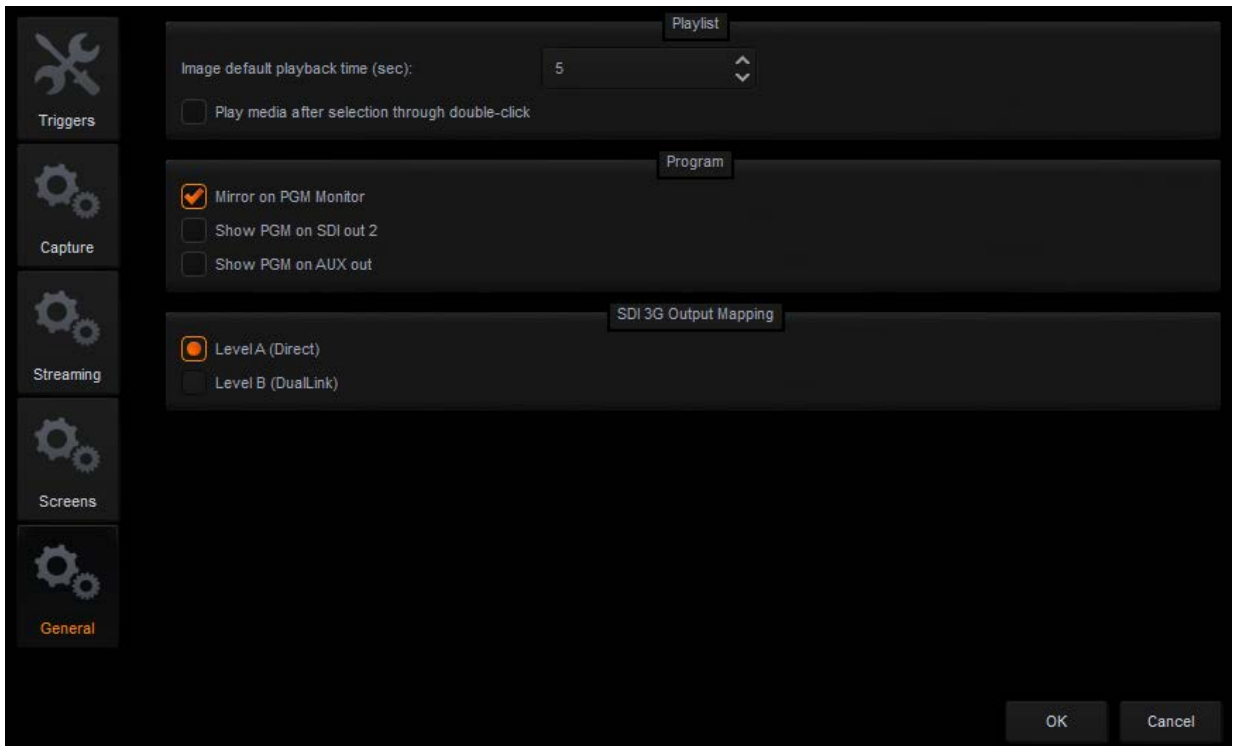

There are two SDI types (Type A and Type B) available on the TVS-1200. Please note that most of the Davideo products adopt type A.

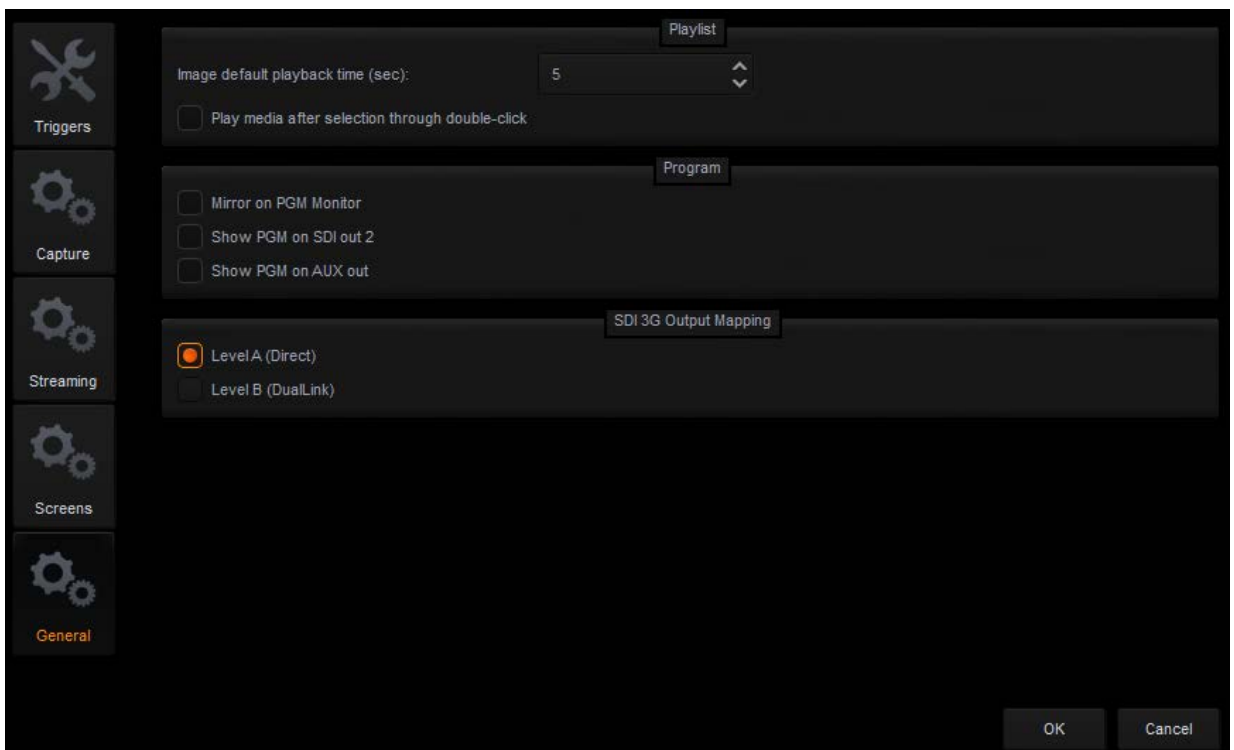

Chapter 6 Chroma and Luma Keys

Keying is a special filter that TVS-1200 uses to remove a specific color (e.g. Green) from the image by applying the filter to the input CAM. CH/L Key 1 applies the filter to the input CAM 1 and CH/L Key 2 applies the filter to the input CAM 2. In this way, for example, talent on a green backdrop can be placed on any virtual background after chromakeying is enabled. The TVS-1200 system supports three keying modes: Chroma Key, Simple Chroma Key and Luma Key.

Chroma Key Mode – This function enables TVS-1200 to be used for chromakeying. Camera input is fed with object on a green or blue backdrop. Background is generated by PC or any other media sources.

Simple Chroma Key Mode – This function enables TVS-1200 to be used for simple chromakeying by performing quick settings of matte, shadow, despill and garbage mask.

Luma Key Mode – This function enables TVS-1200 to be used for luminance-based keying. Camera input is fed with object on a black or white backdrop. Background is generated by PC or any other media sources.

To ensure the best quality, the keying function has a number of parameters available for the user to set the optimal keying. The subsections below outline the Chroma Key configuration process in detail.

6.1 Key Selection

Click on the button  to select the desired key mode as depicted in the diagram below.



6.2 Chroma Key

After selecting the desired key mode, the next step is to select the colour to be keyed out. Clicking on the chrominance keyer button  to enter the configuration screen as shown in the diagram below. This setting depends on the keying background used. There are two

possibilities: green or blue. The choice is made by clicking on **Background Color** in the **Chrominance Keyer** section.

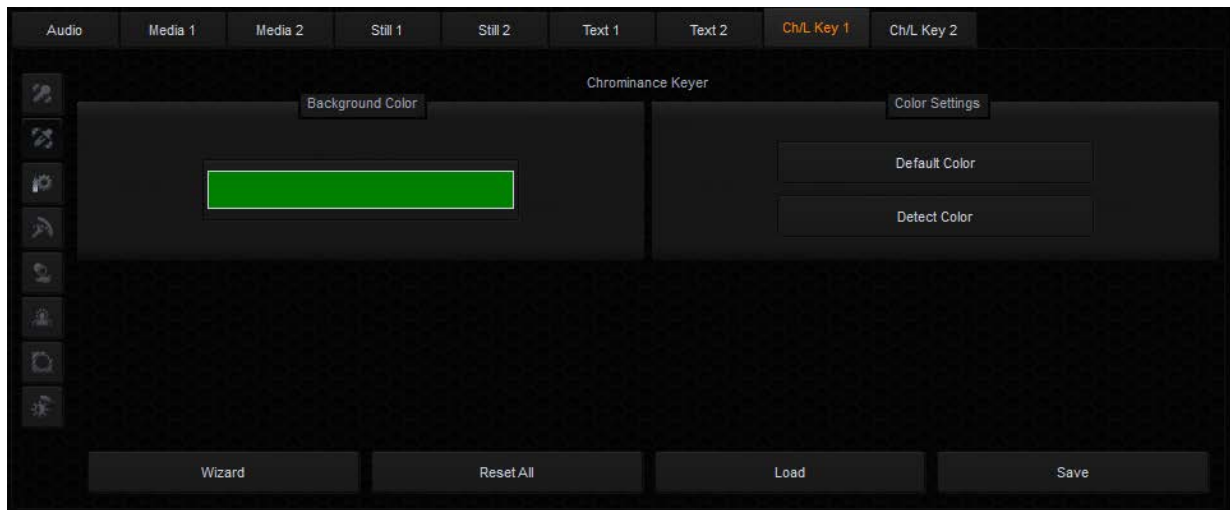

If the colour of the keyed out background is not uniform, the user can make use of the Detect Color button, which will calculate the background's LRGB parameters using the automated average. If the parameters cannot be accessed, the user will be notified about it via a message window, after which the colour will be reset to default. The Default Color button is used to select the default colour.

6.3 Matte Control

Click on the Matte Control button  to enter the preliminary keying setting page. This is done with the **Show Alpha Matte** function, which – after a checkbox is checked – will show a matte view for which colours closer to white are non-transparent and those closer to dark are transparent.

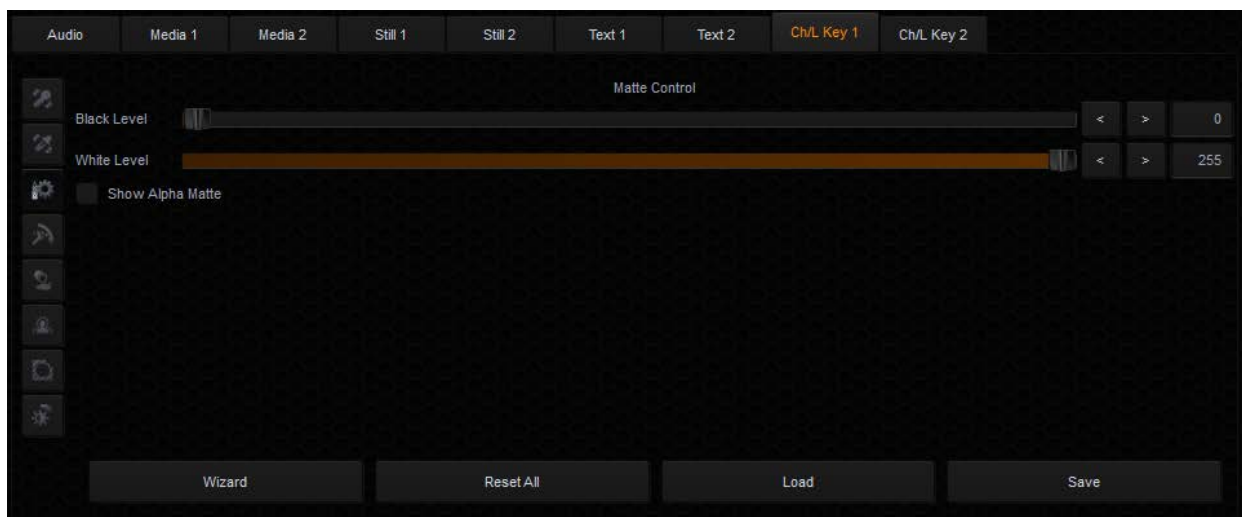



The Show alpha matte view

The intended result is to make the mask background colour as close to perfect black as possible. In order to do that the **Black Level** slider should be moved until black is distributed as evenly as possible on the mask background.



A view after a Black level adjustment

If the slider is moved to the extremes, the other objects will lose their properties and become non-transparent; this is why the function should be applied sparingly so that small differences are still discernible in the distribution of the black background.

The next step is to obtain a uniform distribution of white on objects which will remain fully non-transparent. This uneven distribution may arise from the fact that the colours of the object may have colour components close to the keying colour. In this case an adjustment can be made using the function known as **White Level**.

By moving the slider from the maximum value to the left, you can obtain a perfect distribution of white on a given object.

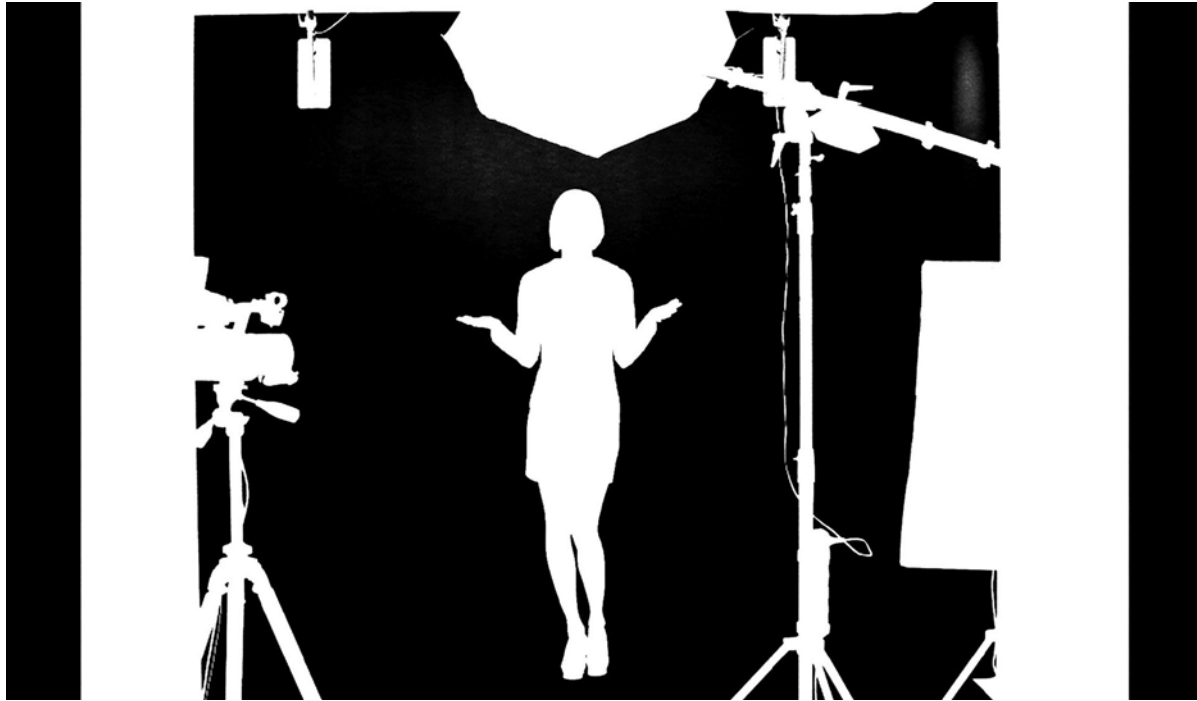

A view after a White level adjustment

In many cases, the option **White Level** will be used in conjunction with the option **Black Level** in order to obtain the most possible effective settings of the black background, with no loss on white objects and vice versa.

6.4 Tolerance Correction

As seen in the view after a White Level adjustment, an extension of the range by means of the **White Level** function usually results in the restoration of a uniformly black surface to slight grays. In this case, in order to adjust the grayness, two further functions from the **Tolerance correction** section are needed. Click on the tolerance correction button  to enter the Tolerance Correction configuration screen.

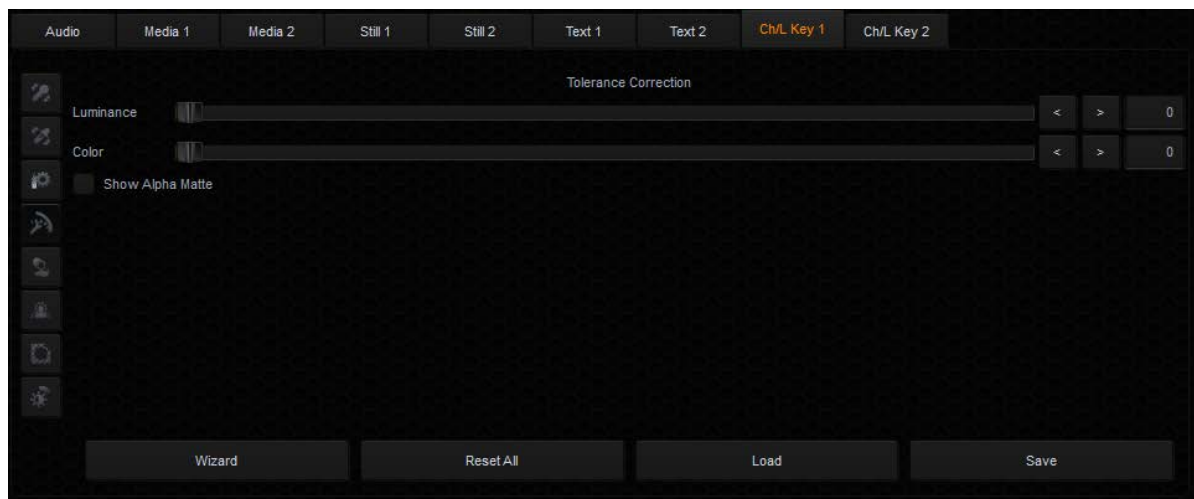

The first function is **Luminance** and it improves the structure of the uniform colour of the white mask.



The second function is called **Color** and its use leads to the restoration to a uniform black structure of the background.



It improves in particular the visibility of an object in the case of a significant difference in luminance between the background and the object. This means that semi-transparent objects, e.g. a glass or glasses, become more distinct. A view 'before' and 'after' an adjustment is presented in the two pictures below.

A view 'before' and 'after'



*A view before a **Luminance** adjustment*



*A view after a **Luminance** adjustment*

The Color function is also used to bring about another effect. Once the option Show alpha matte is switched off and the real picture is restored, it is possible to eliminate unnatural outlines. This can be done by improving the border value between the keyed colour and the object.



*A view before a **Color** adjustment*



*A view after a **Color** adjustment*

6.5 Spill Correction

Spill correction removes keying colour remains (Despill). Once the correct mask is set, the functions in the **Spill correction** section will eliminate the reflection of the colour of the keyed background in the object.



Impact of the background colour on the object – a view before a **Despill** correction

Click on the Spill Correction button  to enter the setting page.



Despill color and **Despill coarse** belong to the functions for the preliminary elimination of unwanted colours, and are based on the RGB space.



The **Despill color/Despill coarse** slider section

Once the **Despill color** slider is moved to position 0 (the left-hand side), the algorithm will automatically remove the green colour component if this is the keyed colour (similarly – blue

if the background is blue). Once the **Despill color** slider is moved to position 1000 (the right-hand side), however, the algorithm will automatically add the red colour and the blue colour (if the keyed colour is green) or red and green (if the background is blue).

The **value** of the algorithm is controlled by means of the **Despill coarse** function. If the keyed background is green, after a certain threshold of the **Despill coarse** function is crossed, the green component is entirely eliminated from the object in the RGB (red, green, blue) space, which results in the transition of colours into the purple (magenta) area.



A view after the green component has been eliminated

Another function enables a more accurate adjustment of the above problem.

The use of the **Despill fine** function eliminates the keyed background colour from the object, but this time on the basis of the chrominance components.



The **Despill fine** slider

After the application of **Despill coarse**, which is used for preliminary correction, more accurate adjustments can be made, and so the **Despill fine** settings may not have any significant impact on the algorithm if **Despill coarse** is set to high.



Impact of the background on the object – a view after a Despill correction

6.6 Edge Correction

Additional correction is applied to improve quality. Click on the Edge Correction button  to enter the setting screen.

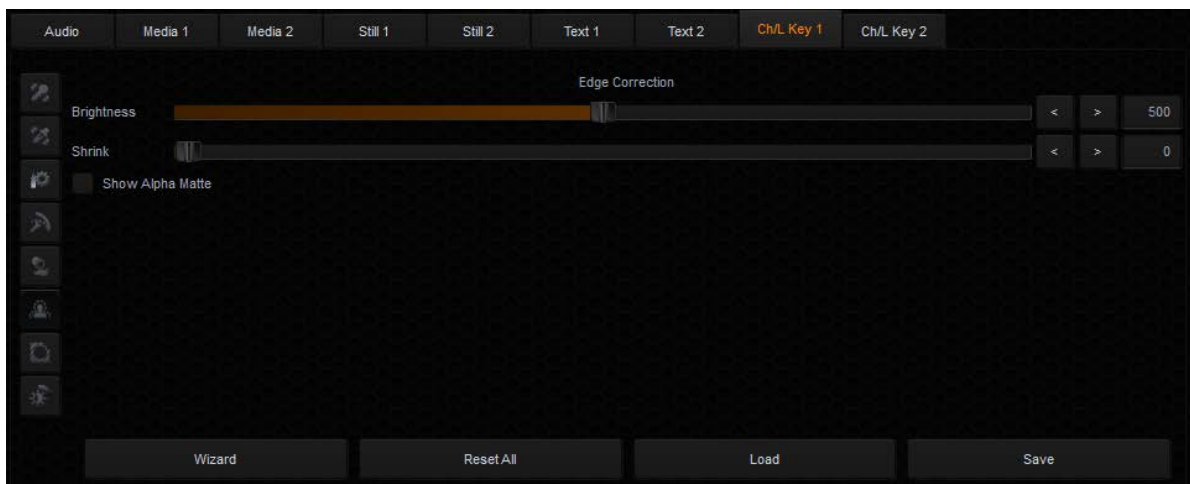

The **Edge Correction** function is used to correct semi-transparent areas (e.g. hair ends that need to be darkened or brightened) in order to make an object look natural.

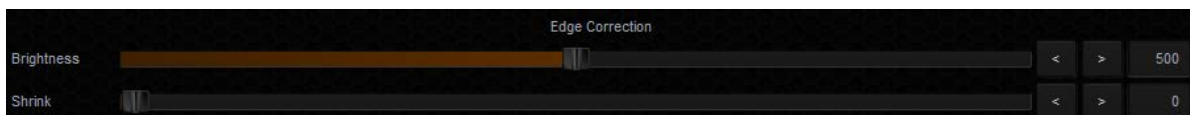

The **Edge brightness** slider

6.7 Garbage Mask

Garbage mask is used to reduce the mask size by cutting it (in all of the possible directions: left, right, up, down). Click on  to configure the garbage mask.

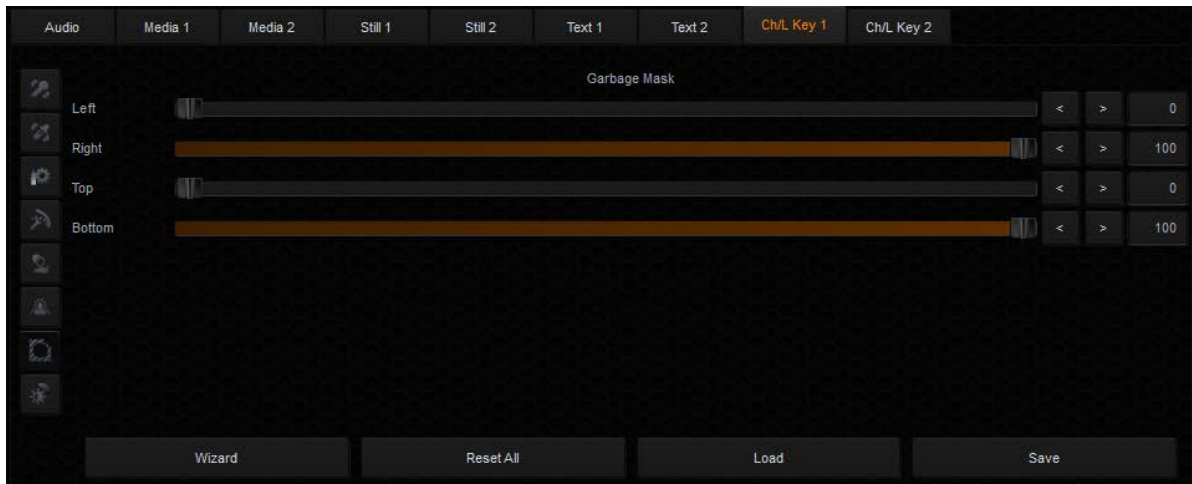

The **Garbage mask** section

This function is used if the view of the keyed background is not large enough to fill in the entire object shot.



A view from the camera area

By cutting the remaining elements by means of the sliders **Left**, **Right**, **Top**, **Bottom**, it is possible to place the object within the area of the keyed background.



A view after a **Garbage mask** correction with the keying algorithm switched off

After enabling the chroma keying function, the following effect is obtained.



A view after the **Garbage mask** correction with the keying algorithm switched on

Comments: It should be kept in mind that in this case the object may only move within the area of the cut off mask – otherwise the object will disappear.

Furthermore, if the Garbage mask sliders are used, it is possible to check whether the previous settings were correct and whether they had any influence on the final look of the virtual background. By moving for instance the Left slider within its full range, no noise, colour shifts or changes in the background grayness should be visible.

6.8 Post Correction

Post Correction  matches the object to the conditions of the virtual background. The following functions illustrated in the diagram below are used for post-correction of the object and have no effect on its virtual background.

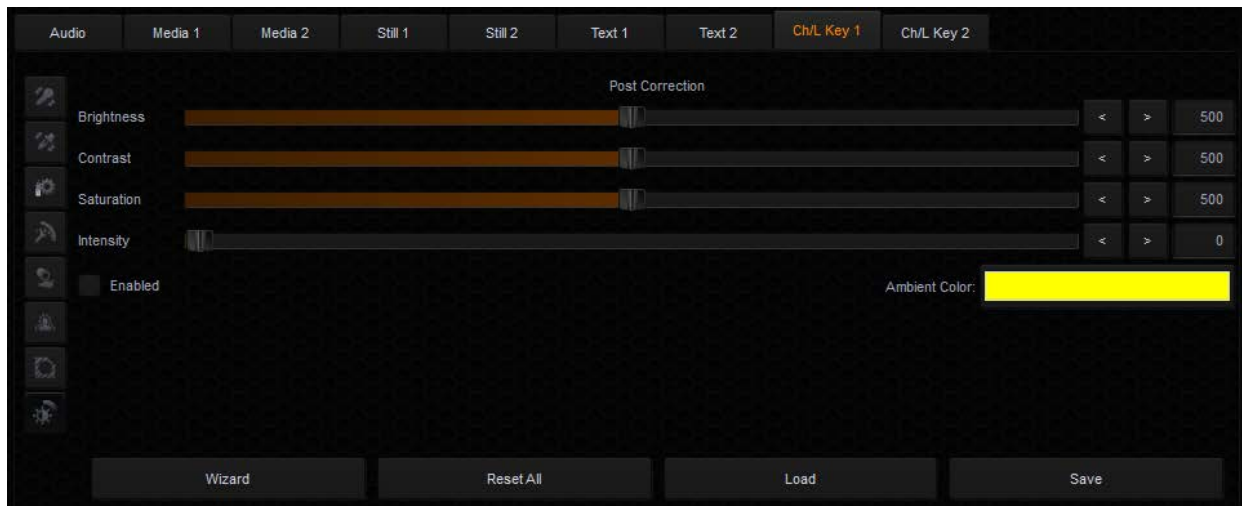

Brightness – this enables additional colour brightness to be introduced into the picture.

Contrast – this enables the contrast between colours to be increased.

Saturation – this enables colour saturation to be boosted.

Intensity – this enables the ambient colour intensity to be set.

Chapter 7 Fast Chromakeying

The TVS-1200 comes with two special features that allow the user to perform fast chromakeying. The two special features are Simple Chroma Key and the Wizard.

7.1 Simple Chroma Key

Simple Chroma Key mode gives the user the capability to apply the chromakeying effect with a single mouse click.

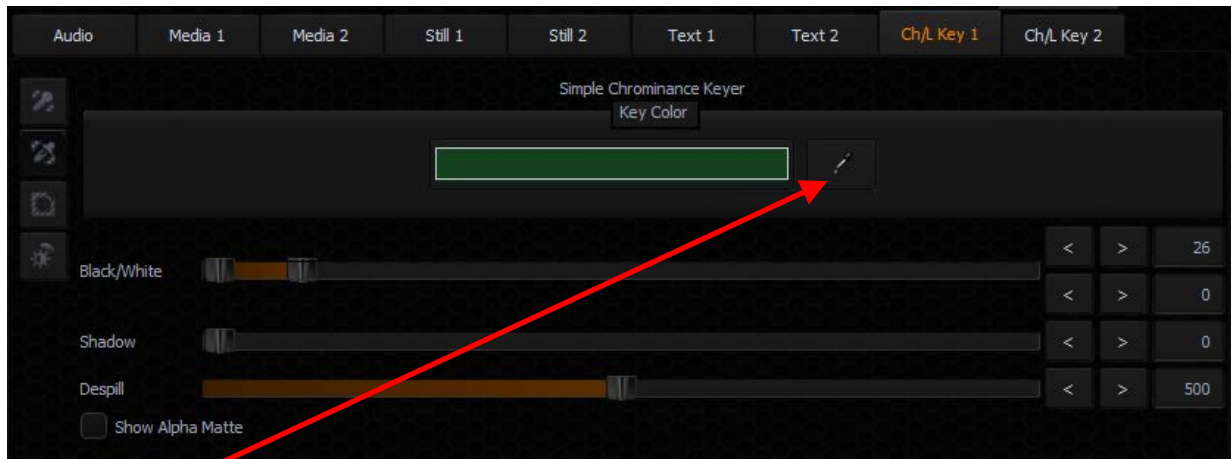

Click on  and the system will automatically select the optimum chroma key color.

7.2 Wizard

The Chroma Key Wizard is designed to guide the user to perform chromakeying step by step. Click on the **“Wizard”** button enclosed in the red rectangular box as shown in the diagram below to start the chromakeying wizard.

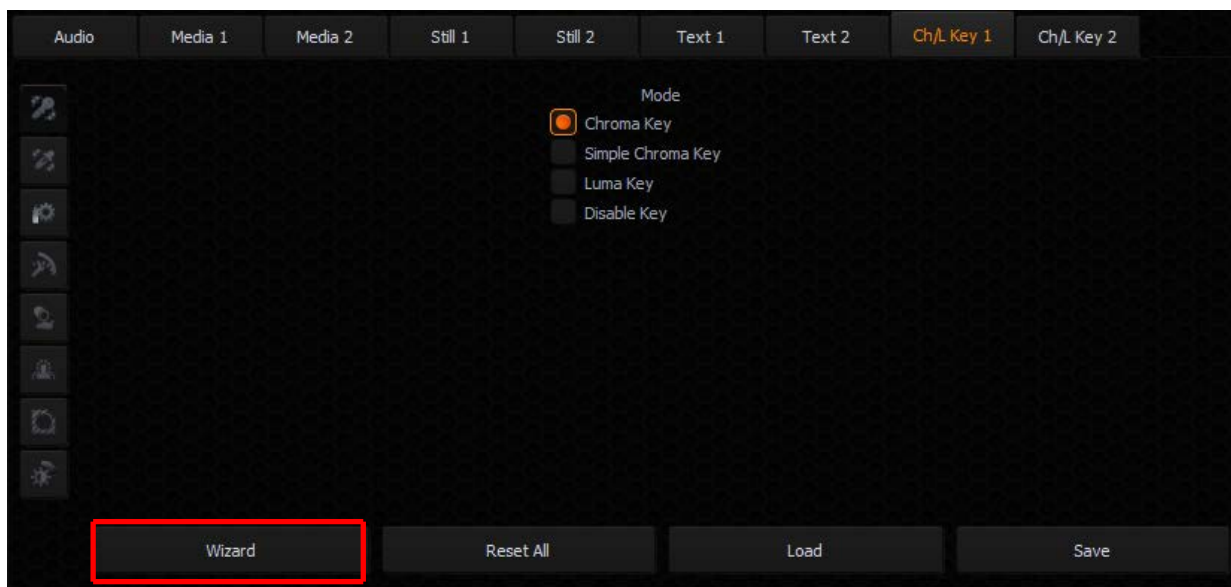

Chapter 8 Sound mixer

TVS-1200 comes equipped with a sound mixer function, which is responsible for mixing sound signals. It also allows the user to adjust the signal level for each source and separately for the sound output.



The sound mixer allows the user to adjust the following channels:

- Line IN (3.5 mm Phone Jack) – an external input channel (stereo analogue input on the input card);
- CAM 1 – audio input channel of camera 1
- CAM 2 – audio input channel of camera 2
- Media1 – an input channel from files played by the virtual player supported by the Media1 Bin tab;
- Media2 – an input channel from files played by the virtual player supported by the Media2 Bin tab;
- Capture – the TVS-1200 system captured audio input
- Streaming – audio output of the streaming channel
- Master Out – an audio output channel

The signal level for each channel can be set with a slider next to the signal level bar. Additionally, a separate Master Out slider can be used to set the output signal level. The Master Out slider is also displayed next to the Program window. Sound can be adjusted from -42 dB to +10 dB. The 0 level corresponds to -10 dBV (-7.8 dBu or 0.316 V RMS).

Also, the following functions can be turned on for each input channel:

- Follow – This function mutes the sound of the selected channel until the video signal associated with the sound source comes on air. This is related to Media1, Media2, and the CAM source associated with Line IN. Switching on this function with a selected channel causes the sound of a given source to be muted if the source is not streamed (shown) to the PGM output.
- Solo – This function sends the selected signal to the output separately. Switching on this function with a selected channel causes the other input channels to be muted. Only the signal for which the SOLO function has been enabled is sent to the outputs.
- Mute – This function completely mutes the signal for a given source.

Chapter 9 Motion Capture Specification

TVS-1200 uses Intel® Quick Sync Video technology, which is a built-in feature in some of Intel processors. It allows hardware acceleration of video stream encoding. TVS-1200 also supports capturing of system PGM output. This enables the use of TVS-1200 as a video recorder and is usually used in live production. The file is created in the MP4 or MPEG2 format.



Supported encoding formats (CODEC) are:

- H.264
- MPEG-2
- AVI with Alpha Channel (Lagarith lossless video CODEC)



The CODEC supports the video formats listed below:

- 1080i60 / 59.94 / 50
- 1080p60 / 59.94 / 50 / 30 / 29.97 / 25
- 720p60 / 59.94 / 50

The user can perform simple manual settings such as selection of low, normal, high and customized quality. All other parameters such as profiles, bitrate and etc. are configured internally. Selection of custom bitrate allows the user to customize the recording bitrate. In addition, the user is also allowed to define the default captured video file saving directory.

After all capture settings are configured, to start recording the live program, click the Capture button and the button will turn amber as shown in the diagram placed at the beginning of this section. Click the Capture button again to stop recording and the recorded program will be placed in **section 5 of the media tab** (media 1 and 2) as shown below.



In addition to program video recording, the user can also grab instantaneous images on the Program view by clicking on the STILL/GRAB button. The grabbed images are saved in PGN format.



The grabbed images will be added to **section 5 of both Still tabs of the Media Bin** (Still 1 or Still 2) shown below.





Chapter 10 Program Video Stream

This function makes sending the broadcast signal in the form of an Internet data stream possible. As a result, live programs can reach all viewers in real time, even in remote areas. TVS-1200 is the main element for such realization because in addition to creating a broadcast signal, it is also capable of converting the broadcast signal into a network data stream.

To start Internet broadcasting, the user should:

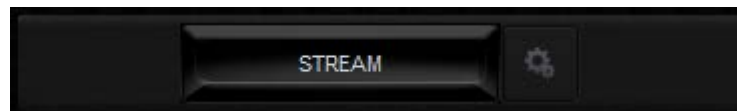
- Generate a source signal – made available by Live Production;
- Convert the signal to a format supported by Internet connection;
- Trigger online broadcast by clicking on the STREAM button shown below.



To configure the streaming setting, click on  located on the right of the stream button to open the configuration window as illustrated below. Define your streaming service and configure video and audio settings accordingly. The available streaming services are:

- Niconico
- UStream
- Youtube
- Custom

After configuring the stream setting, you may also save your configuration in xml format on the hard disk for future use. To import the configuration file, simply click the “Import FMLE profile...” button to start the import process.



Chapter 11 External Keyboards

The user is allowed to control TVS-1200 with external keyboards such as an RMC-220 Remote Controller and a standard keyboard. Details of each are outlined in the following sections.

11.1 RMC-220 Function Keys

There are 10 user-defined function keys, F1 to F10, on RMC-220 Remote Controller. These function keys are configurable on the TVS-1200 system. Each of these function keys can be assigned of multiple functions selected from the table below:

Audio	DSK	General	Mix Effect	Media	Output
Capture Mute	Set Position	Delay	Import Studio	Auto Play	Select Preview
Capture Volume	Set Preview		Set AutoPlay	Loop Play	Select Program
Input Mute	Set Rotation		Set Bus A Source	Pause	Set T-Bar Position
Input Solo	Set Scale		Set Bus B Source	Play	Transition Cross-Dissolve
Input Volume	Set Source		Set Bus C Source	Select	Transition Fade to Black
Output Mute	Transition Cut		Set Phase	Stop	
Output Volume	Transition Fade		Set Speed		
Streaming Mute					
Streaming Volume					

The user just needs to press the function key once to execute the selected functions according to the sequence in which the functions are selected.

To assign specific multiple functions to these 10 function keys, open the TVS-1200 configuration window and click on “**Triggers**” button. Function key tabs can be found at the top of the configuration window. Click on the Function Key tab that you would like to customize and in the example below, Key F1 is selected.





In general, two modes are available and they are “**Simple**” and “**Advanced**”.

11.1.1 Advanced

In Advanced mode, the user is allowed to select all available functions in the above table. Furthermore, the execution sequence of the selected functions is customizable.

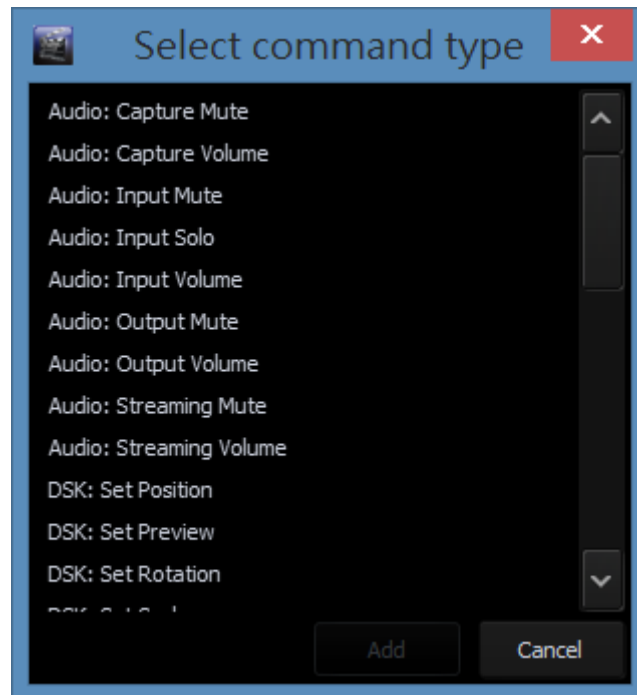
Select “Advanced” and Click on  to open a command selection window shown below.



Select a function, for example, “DSK: Set Source #1” as shown in the diagram below and then set the corresponding parameters. Click on  again to select the next function until all desired functions are selected.

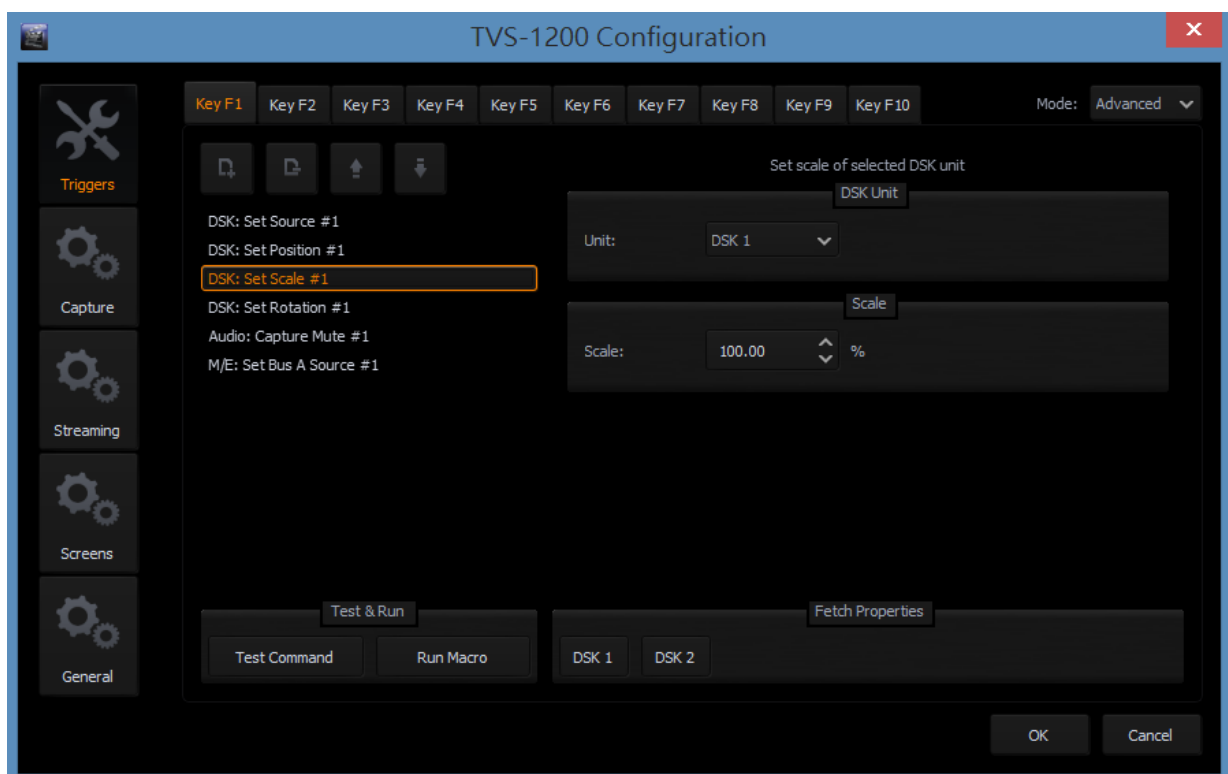

After all the desired functions are selected, click on the next key tab and repeat the above until all keys are assigned the functions that you desire.

11.1.2 Simple

If the user's selection is "Simple" Mode, a user interface will appear as shown in the diagram below. On the interface, the user is only given the Graphics Overlay function (Media Stream) to perform simple customization of the function key. After the function key is customized, pressing the RMC-220 function key button will play the media stream and again to reverse the media stream playback.

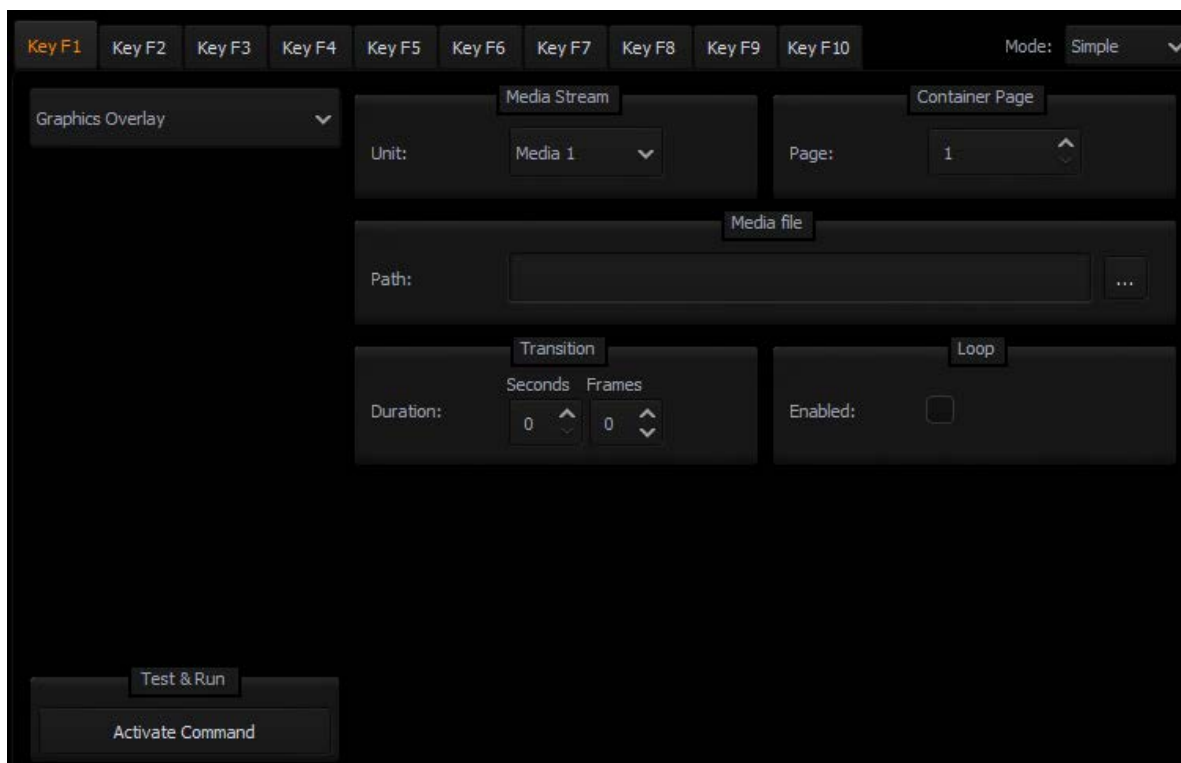

11.2 Standard Windows Keyboard Shortcuts

Functions	Shortcut Keys
PGM Bus on the main switcher	Q, W, E, R, T, Y, U, I, and O
PRV Bus on the main switcher	A, S, D, F, G, H, J, K, and L
Switching between M/E	F1, F2, F3, and F4
Switching between phases of active M/E	1, 2, and 3
DSK1	Insert
DSK2	Home
Source for DSK1	Delete
Source for DSK2	End
Display on PGM screen with Cut	Page Up
Display on PGM screen with Fade	Page Down
TAKE	Enter (num lock key pads)

Chapter 12 System Recovery

TVS-1200 also offers the user a system recovery mechanism when the system is unstable. Reboot TVS-1200 and during the system boot-up process, select the DriveClone System Recovery option to enter the recovery process when the screen below appears. This recovery process resets C drive to factory default but keeps the data on D drive.



Click on the Next button on the introduction page of the recovery process

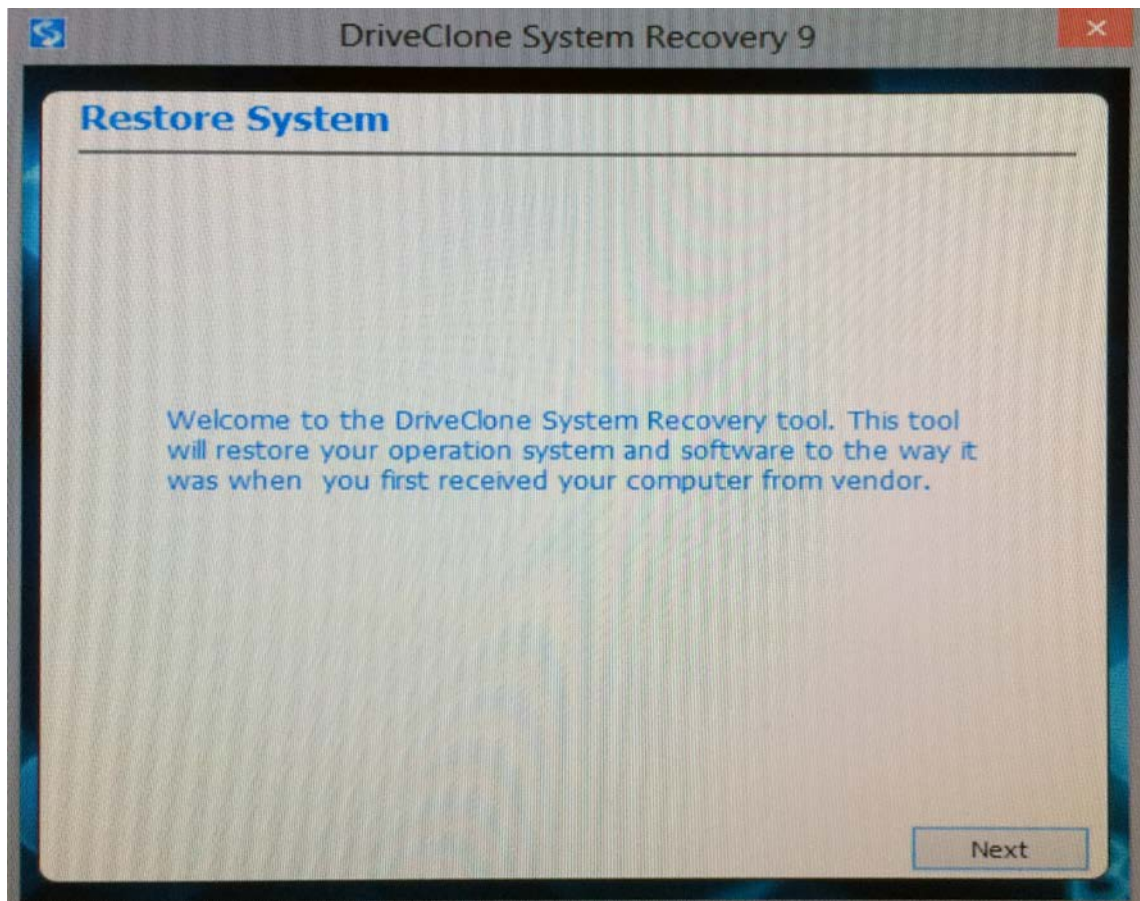

Select the appropriate recovery option and click on the Start button

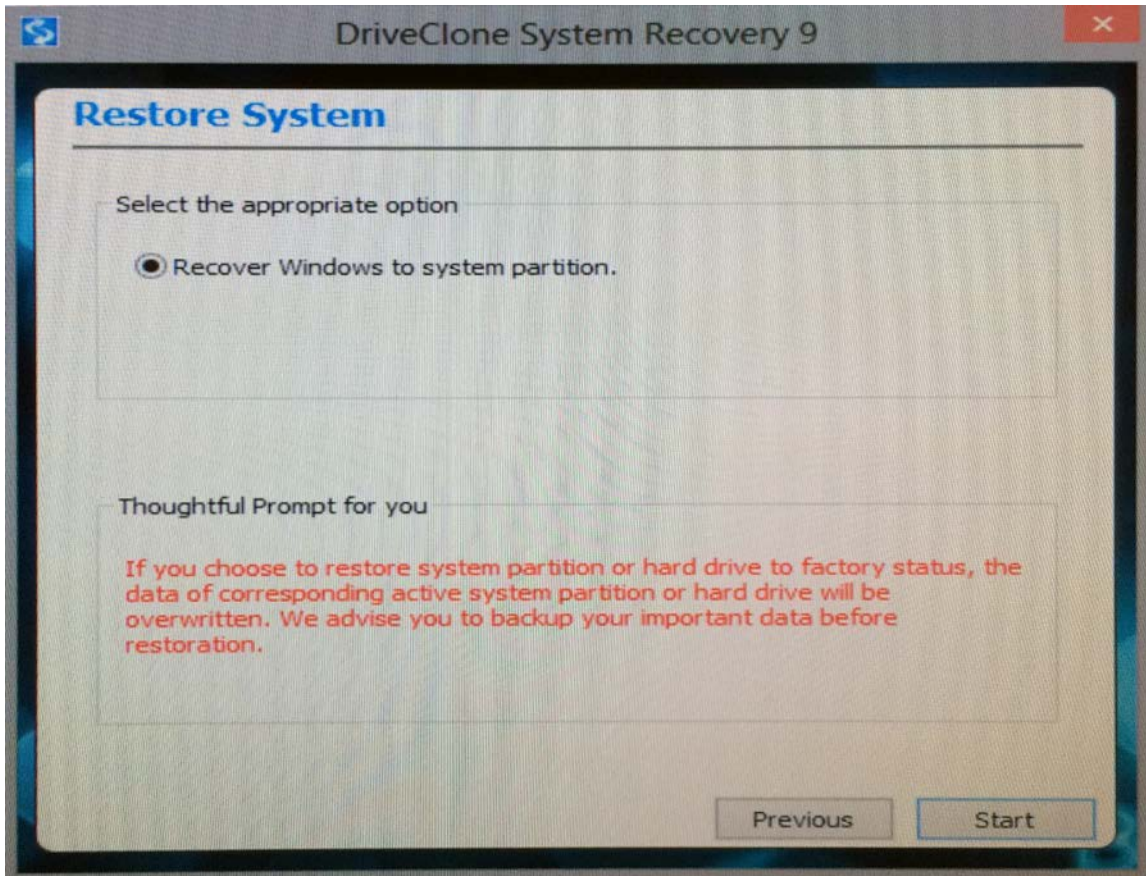

Wait till the progress bar shows 100% completion

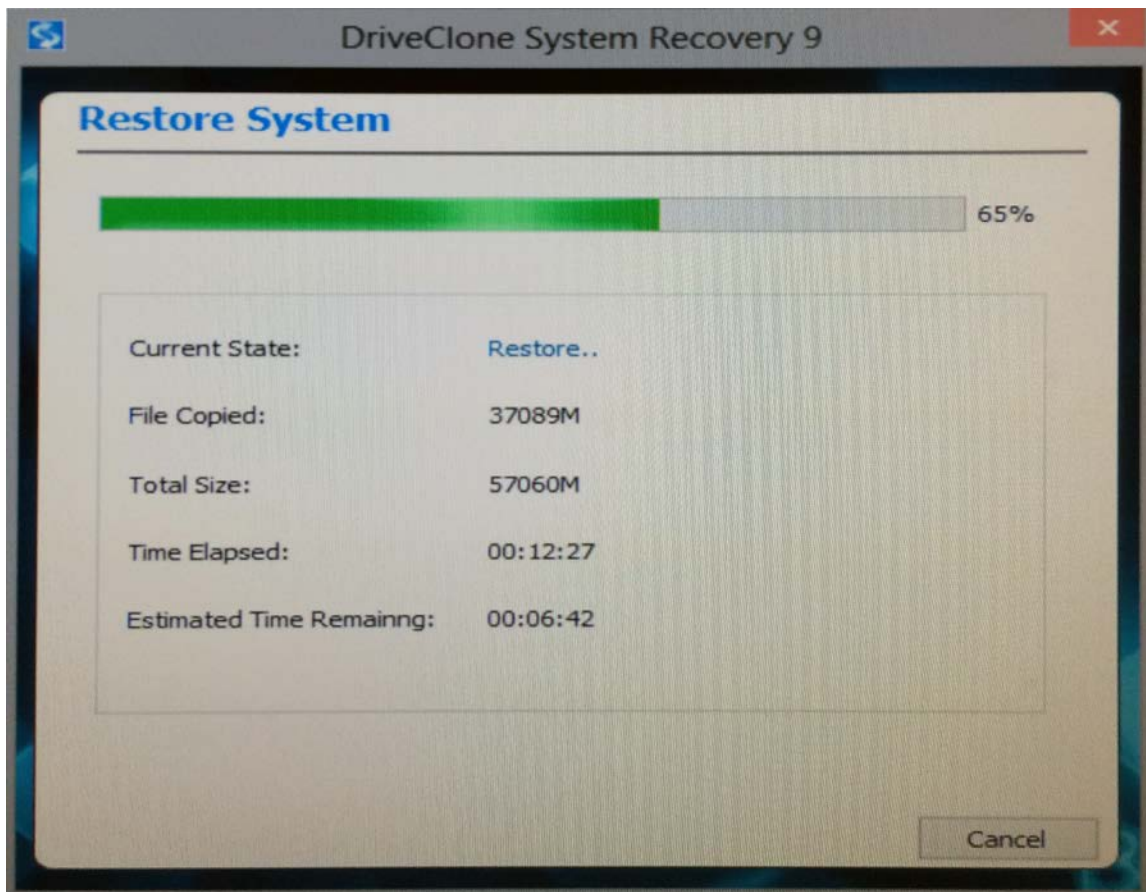

Once the recovery process is finished, click on OK button to trigger system reboot

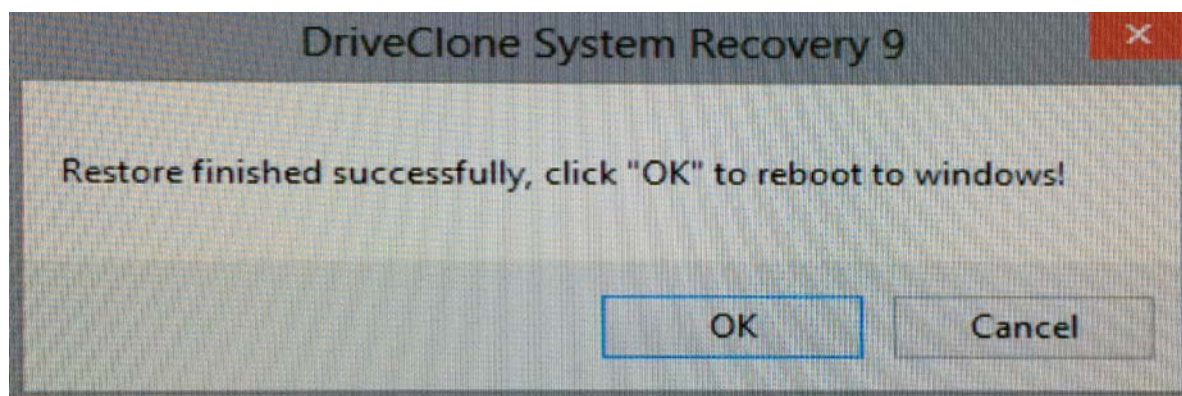

Chapter 13 Frequently-Asked Questions

This section describes problems that you may encounter while using TVS-1200. If you have questions, please refer to related sections and follow all the suggested solutions. If problem still exists, please contact your distributor or the service center.

No.	Problems	Solutions
1	.avi files cannot be played in Media 1/2.	TVS-1200 does not support avi format.
2	Still pictures and texts cannot be previewed in Still 1/2 and Text 1/2.	This only occurs occasionally and files can still be opened.
3	Why does the TVS system exit to Windows desktop right after monitor cable is unplugged while TVS system is running?	TVS system has to work with monitors connected, please do not unplug monitor while the TVS system is still running.
4	Why the Windows Media Player cannot play the MPEG file captured using the TVS system?	Please use VLC Player, which is a freeware. Windows Media Player cannot play MPEG II files.
5	Why, after renaming the captured file in the TVS system, the file name on the Windows OS remains unchanged?	The TVS system only allows local renaming of the captured files during any TVS session, and does not rename the actual file name on the PC system. This is because a single file can be referenced by many other projects or sessions so if the actual file name on the PC system is renamed, the reference to other projects/sessions will be lost.
6	After "Follow" is enabled for Line IN on the TVS audio mixer, the Line IN audio is found to output with CAM1 or Cam2.	The Line in will follow Cam1 or Cam2 after the "Follow" check box is checked. If you do not want the Line in Audio, please select Mute for Line in.
7	Why does the screen viewable area become smaller right after bootup of the TVS machine?	This may happen in some monitors. Please activate overscan mode of the monitor.
8	Why the file cannot be found or the file is blank after the virtualset maker file (.dvsx) is renamed under the Windows OS and imported into the TVS Production Module?	While renaming the VirtualSet Maker files (.dvsx), please also rename the corresponding .PNG files in the same folder.
9	Why are there warning signs on my multi-viewer?	Please make sure all the resolutions and frame rate are same as your session resolution and frame rate which you assigned on the startup menu before production.
10	Why can't I see objects under lower layer in Virtualset Maker main window?	Please make sure your upper layer objects are PNG file with Alpha Channel so that the upper layer will not block lower layers.

11	Why can't I adjust the size and position for specific layer in Virtualset maker?	Please make sure you are not adjusting the Studio Layer, which is a background layer not meant to be adjustable. However, you can adjust the Static Layer. Please click the "add" button and then select the Static layer by clicking on the picture you wish to re-size or re-position.
12	I cannot hear audio output from TVS-1200 PGM OUT while the output is set to 1080P 50/60, however, I can see the video.	If your output is set to 1080P 50/60, please make sure the SDI 3G output mapping (Configuration / Configuration / General) is correctly selected (Type A or Type B).
13	The order of the three monitors is not the order that I want.	Please adjust the monitor order in the TVS Monitor configuration settings. (Configuration / Configuration / screens / monitor configuration)
14	What codec should I use if I want to create a downstream key that has an animation effect with Alpha Channel?	Please use Lagarith Lossless to make .avi file, or DNxHD to make .mov file. Please make sure to select RGBA format which includes Alpha Channel.
15	It is difficult to move Source Media to the location that I want in Virtualset Maker?	In Points Mode, you can pull the four corners to move the Source Media to the location that you desire.
16	Why is there no sound from Aux card (Green card) HDMI output?	Aux Card for PVW output does not include audio. The PGM output supports Audio embedded.
17	Why is there no video out while feeding the Aux card (Green Card) HDMI output with 1080P 50 / 59.964 / 60 inputs?	Aux Card does not support 1080P 50 / 59.964 / 60 format. Please use lower resolution format.
18	Why is there only 2 audio channel output when I use an 8 audio channel input?	TVS supports 2 audio channels only.
19	How to monitor the PGM audio?	The user can use a TV or a monitor with earphone connector or speaker and connect it to PGM OUT.
20	What are the other compatible NLE versions?	The following NLE SW supports H.264 coding 1. Premiere Pro CC 2014 and later 2. Final Cut Pro X and above 3. EDIUS Pro 7 and above In addition Premiere Pro CC 2015 and later are the NLE SW that supports MPEG-II encoding (INTEL HD4600).

Chapter 14 Specifications

Video Input	3G/HD/SD-SDI x 2
Video Output	3G/HD/SD-SDI x 2
Video Input Format	SMPTE-425M 1080p (60/59.94/50/30/25) 1080i (60/59.94/50) SMPTE-274M 1080p (30/29.97/25) HD-SDI 3 Gb/s SMPTE-296M 720p (60/59.94/50)
Analog Audio Input	3.5mm phone jack x 1 Aux 2 CH stereo audio input
Audio Output	3G/HD/SD-SDI
Audio Format	.mp3 .aac
Tally Output	3.5mm phone jack x 1
Downstream Key	2
Media Format	H.264 AAC AMR DVCPProHD DVCPPro50 DVCPPro JPEG2000 MJPEG MPEG-2 MPEG-4 VC-1 MP4 MXF DV WMV
Video Capture Format	H.264 (.mpeg4, .h264) MPEG-2 (.mpg)
Still Picture	2
Picture Format	.png .jpg
Still Text	2 (Still Text Editor included)
Keyer	Chroma Key/Luminance Key
Recording	H.264/MPEG-2
Hard Disk	2.5-inch removable hard drive

Chapter 15 TVS-1200 AUX Card

15.1 Introduction

TVS Virtu AUX Card is designed primarily for powerpoint file input via HDMI port as well as for other applications such as media player or camera input. TVS AUX card can also be used in TVS-1200.

15.2 Installation

1. Insert AUX card in PCIe slot
2. For TVS-VIRTU HDMI Card Version 1.4, use the cable shown below to connect between TVS Virtu AUX card and TVS Virtu SDI card



The cable connection between TVS Virtu AUX card and TVS Virtu SDI card is depicted in the diagram below. The location of the slot for the cable connection is circled in red as shown below.



15.3 Specification

TVS Virtu Aux Card	
Video Input	HDMI x 1
Video Output	HDMI x 1 (Preview without audio)
Video Input Format	1080 30P / 29.97P / 25P 1080 60i / 59.94i / 50i 720 60P / 59.94P / 50P
Audio Input	Mini Phone Jack x 1 HDMI audio embedded

Service & Support

It is our goal to make owning and using Datavideo products a satisfying experience. Our support staff is available to assist you to set up and operate your system. Contact your local office for specific support requests. Plus, please visit www.datavideo.com to access our FAQ section.

Datavideo Taiwan

Datavideo Technologies Co. Ltd
10F. No. 176, Jian 1st Rd., Chung Ho
District, New Taipei City 235, Taiwan,
R.O.C.
Tel: +886-2-8227-2888
Fax: +886-2-8227-2777
E-mail: service@datavideo.com.tw

Datavideo Europe

Datavideo Technologies Europe BV
Floridadreef 106
3565 AM Utrecht,
The Netherlands
Tel: +31-30-261-96-56
Fax: +31-30-261-96-57
E-mail: info@datavideo.nl

Datavideo United Kingdom

Datavideo UK Limited
Units 1 & 2 Waterside Business Park
Hadfield, Glossop, Derbyshire
SK13 1BE, UK
Tel: +44-1457 851 000
Fax: +44-1457 850 964
E-mail: sales@datavideo.co.uk

Datavideo USA

Datavideo Corporation
7048 Elmer Avenue.
Whittier, CA 90602,
U.S.A.
Tel: +1-562-696 2324
Fax: +1-562-698 6930
E-mail: sales@datavideo.us

Datavideo China

Datavideo Technologies China Co
101, NO.618, LiuYing Rd, Zhabei District,
Shanghai, China
Tel: +86 21-5603 6599
Fax: +86 21-5603 6770
E-mail: service@datavideo.cn

Datavideo Singapore

Datavideo Technologies (S) PTE Ltd
No. 178 Paya Lebar Road #06-03
Singapore 409030
Tel: +65-6749 6866
Fax: +65-6749 3266
E-mail: sales@datavideo.sg

Datavideo Hong Kong

Datavideo Hong Kong Ltd
G/F., 26 Cross Lane
Wanchai, Hong Kong
Tel: +852-2833-1981
Fax: +852-2833-9916
E-mail: info@datavideo.com.hk

Datavideo France

Datavideo France s.a.r.l
Cité Descartes 1, rue Albert Einstein
Champs sur Marne
774477-Marne la Vallée cedex 2
Tel: +33-1-60370246
E-mail: info@datavideo.fr

Datavideo India

Datavideo Technologies India Pvt Ltd
A-132, Sec-63, Noida-201307,
Uttar Pradesh (UP), India.
Tel: +91-0120-2427337
Fax: +91-0120-2427338
E-mail: sales@datavideo.in



Please refer to our website for update the latest version manual.
www.datavideo.com/Virtual+Studio/TVS-1200

datavideo
www.datavideo.com