

MAINTENANCE AND OPERATION
INSTRUCTION MANUAL

DB91-TX

Compact IP Audio Encoder



Contents

Introduction	5
Typographic conventions	6
General Information	7
Product Features	8
Technical Specifications	9
Panel Indicators and Appointments	11
<i>Front Panel</i>	<i>11</i>
<i>Rear Panel</i>	<i>12</i>
Block diagram	13
Before you start	14
<i>Safety Warning</i>	<i>14</i>
<i>Operating recommendations</i>	<i>14</i>
<i>Unpacking and inspection</i>	<i>14</i>
Mounting	15
<i>Heat Dissipation</i>	<i>15</i>
<i>Radio Frequency Interference</i>	<i>15</i>
Basic Setup	16
<i>Analog Audio Inputs</i>	<i>16</i>
<i>Digital Audio Inputs</i>	<i>16</i>
<i>LAN port</i>	<i>16</i>
WEB Interface	17
<i>Network Discovery</i>	<i>17</i>
<i>Access</i>	<i>17</i>
WEB Interface Menu pages	18
<i>Status</i>	<i>18</i>
<i>Settings</i>	<i>19</i>
<i>Input</i>	<i>20</i>
<i>Encoding</i>	<i>22</i>
<i>Encoder Type MP3</i>	<i>22</i>
<i>Encoder Type HE-AAC</i>	<i>23</i>
<i>IP Audio</i>	<i>24</i>
<i>IP Audio Server</i>	<i>24</i>
<i>IP Audio Sender 1/2/3</i>	<i>25</i>
<i>General</i>	<i>26</i>
<i>Network</i>	<i>27</i>
<i>Network</i>	<i>27</i>
<i>E-mail</i>	<i>28</i>
<i>HTTP Server</i>	<i>28</i>
<i>FTP Server</i>	<i>28</i>
<i>SNMP Agent</i>	<i>28</i>
<i>Other</i>	<i>29</i>
<i>Firmware Update</i>	<i>29</i>
<i>Storage</i>	<i>29</i>
<i>Factory Defaults</i>	<i>29</i>
<i>Reboot Device</i>	<i>29</i>
<i>System Log</i>	<i>30</i>
<i>Hardware Reset</i>	<i>31</i>
<i>Network Default Settings</i>	<i>31</i>
<i>WEB Server Default Settings</i>	<i>31</i>

APPENDIX A	32
<i>How should I configure the connection between my DEVA Device and an FTP Client?</i>	32
1. <i>FTP Server Settings</i>	32
2. <i>IP Router and Port Translation Settings</i>	32
3. <i>Example of FTP Client (FileZilla) Settings</i>	33
WARRANTY TERMS AND CONDITIONS	34
Product Registration Card	35

THIS PAGE
IS INTENTIONALLY
LEFT BLANK

Introduction

DEVA Broadcast Ltd. is an international communications and high-technology manufacturing organization, its corporate headquarters and facility located in Burgas, Bulgaria. The company serves the broadcast and corporate markets worldwide – from consumers and small businesses to the largest global organizations. It is dedicated to the research, design, development and provision of advanced products, systems and services. DEVA launched its own brand back in 1997 and has nowadays evolved to become known as a market leader and internationally reputed manufacturer of user-friendly, cost-effective and innovative broadcast products.

Creativity and innovation are deeply woven into DEVA corporate culture. Through successful engineering, marketing and management our team of dedicated professionals creates future-oriented solutions to improve customers' performance. You may rely that all issues communicated to our crew would be addressed accordingly. We pride ourselves on our pre and post-sales support and purchase services, which along with the outstanding quality of our radio gear have won us due respect and the market authority position.

DEVA best-of-breed solutions have become the best sellers for our partners. The strategic partnerships which have been formed with industry leaders during all these years that we have been operating on the broadcasting market, have proved us a reliable business partner and a valuable asset, as our dealers worldwide would confirm. In constant pursuit of precision and long-term satisfaction, DEVA enhances the reputation of our partners and clients alike. Furthermore, we have already a proven merit as a credible partner provider.

Our portfolio offers complete line of high quality and competitive products for FM and Digital Radio, Radio Networks, Telecommunication Operators and regulation authorities. For almost two decades of intensive software and hardware development, we have achieved a unique price-performance and endurance of our product lines. Our company's multitude of equipment and services is in line with the latest technologies and key trends. The most recognizable characteristics attributed to DEVA products are their clear-cut, streamlined design, easiness of use and cost-effectiveness: simplicity of forms but multiplicity of functions.

For us there is no stage when we deem that we have reached the most satisfactory level in our work. Our engineers are in constant pursuit of new ideas and technologies to be captured in DEVA solutions. Simultaneously, a strict control is being exercised at each step of any new development. Experience and hard work are our fundament but the continuous improving process is what we never leave aside. DEVA participates on a regular basis in all landmark broadcasting events, not only to promote its products, but to exchange valuable know-how and experience. We are also engaged in international large-scale projects involving radio and audio solutions which makes us even more competitive on the global market.

All DEVA products are developed and produced in accordance with the latest ISO 9001 quality control standards.

Typographic conventions

This manual uses the following typographic conventions:

Style	Used for
NOTE	Important notes and recommendations
Example	Used when example text is cited
“Menu” on page XX.	References
[OK]	Interface Interactive buttons.
<i>Settings</i>	Menu paths are represented as follows: <i>Settings</i> > <i>General</i> > <i>Backup</i>

General Information

DEVA's in-depth expertise in IP Audio technologies meets cutting-edge trends in DB91-TX, designed to guarantee you outstanding performance. This second generation IP Audio encoder converts the audio signal into high quality compressed audio stream, and transmits the output signal directly over IP-based networks. To ensure audio transmission without quality loss, DB91-TX also supports uncompressed PCM audio stream.

Small and compact, this high-tech device enables quick incorporation in the existing audio systems and their respective effortless integration to the Internet. The front panel's audio level bar graphs and LED indicators allow for reading at a glance the current state of the device. In line with DEVA's very essential brand characteristics - easy set-up and monitoring, the DB91-TX could be managed through a simple and intuitive HTML5 interface and any kind of web browser, be it your PC, smart phone or tablet, remotely or locally.

To unit ensures premium broadcasting experience as once the audio source is selected, the encoded in real time audio is immediately transmitted over IP-based networks. The enhanced DB91-TX can act simultaneously as an Icecast/SHOUTcast compatible Server, Icecast source client or Real Time Protocol (RTP) sender. The audio stream can be spread over an IP-based network to one or more DB90-RX, DB91-RX or other compatible IP audio decoders. To address the evolving customer needs, the DB91-TX IP Audio Encoder can also send audio to a number of clients simultaneously, provided that a multicast address is being entered as a client address.

Decades of experience to our credit, expanded tech expertise and understanding of customer's needs have resulted in agiler, trusted and cost-efficient solutions that improve broadcasters' performance. DB91-TX, with its compact form, wide array of enviable features and intuitive control interface is the valuable asset to any enterprise in need of preeminent broadcasting systems and services.

Product Features

- High Quality HE-AAC (v.1 & 2) and MPEG-1 Layer-3 Compression
- 32 kHz, 44.1 and 48 kHz sample rates support
- Up to 88 kbps bitrate for HE-AAC
- Up to 320 kbps bitrate for MPEG-1 Layer-3
- Up to 1536 kbps for PCM
- Analog Audio Input (2 x RCA connectors)
- Digital Audio Input (RCA Connector)
- SHOUTcast / Icecast compatible TCP/IP stream server
- Up to 10 simultaneously connected clients
- SHOUTcast v1 Source
- Icecast Source Client
- Multicast RTP Sender
- 2 x 5 LED front panel audio level bar graphs
- 4 x Status LEDs
- Phones output for quick diagnostics
- IP address pronunciation at startup (through the headphones)
- Full Control and easy setup via a standard web browser
- UPnP for easy discovery in Local Networks

Technical Specifications

AUDIO ENCODER	
Count	2 user selectable plus 1 fixed (PCM)
Codec	HE-AAC (v.1 and v.2), MPEG-1 Layer 3 or raw PCM
Sample rates	32 kHz, 44.1 kHz and 48 kHz
Channels	1 or 2
Bit Rates	Up to 88 kbps (HE-AAC); Up to 320 kbps (MPEG-1); Up to 3072 kbps (PCM);
MPEG-1 LAYER 3 SPECIFIC	
Encoding mode	Mono and Stereo, Joint Stereo or Dual Channel
Emphasis	50µs, CCITT J.17 or none
IP AUDIO SERVER	
Type	SHOUTcast/Icecast compatible TCP/IP stream server
Codec	Any of the available
Count	Up to 10 simultaneously connected clients
ICECAST SOURCE CLIENT	
Type	Icecast Source Client
Codec	Any of the available
Count	Up to 3 independent streams
SHOUTCAST SOURCE	
Type	SHOUTcast v1Source
Codec	Any of the available
Count	Up to 3 independent streams
RTP SENDER	
Type	Unicast/Multicast RTP Sender
Codec	Any of the available
Count	Up to 3 independent streams
ANALOG AUDIO INPUT	
Connector	2 x RCA, stereo
Type	Unbalanced
Level	+6 dBu (max. +8dBu), user selectable
Sample rate	32 kHz, 44.1 kHz and 48 kHz
Dynamic range	102 dB
DIGITAL AUDIO INPUT	
Connector	RCA
Type	S/PDIF (IEC 60958)
Resampling	Thru build-in sample rate converter

FRONT PANEL	
Level indicators	2 x 5 LED bar graphs
Status Indicators	4 LEDs
Headphones	1/8" (3.5mm) phones jack
SD Card	microSD card slot
USER INTERFACE	
Indicators	14 LEDs on front panel
Web interface	Full control and status information
NETWORK	
Connector	RJ-45
Type	Ethernet
Device discovery	UPnP support
OPERATING CONDITIONS	
Temperature	10°C - 45°C
Humidity	< 75%, non-condensing
POWER REQUIREMENTS	
Connector	Power Jack 5.5mm
Power supply	12V DC, 1A
SIZE AND WEIGHT	
Dimensions (W;H;D)	106 x 33 x 128 mm
Shipping Weight	230 x 54 x 172 mm / 0.7kg

Panel Indicators and Appointments

FRONT PANEL

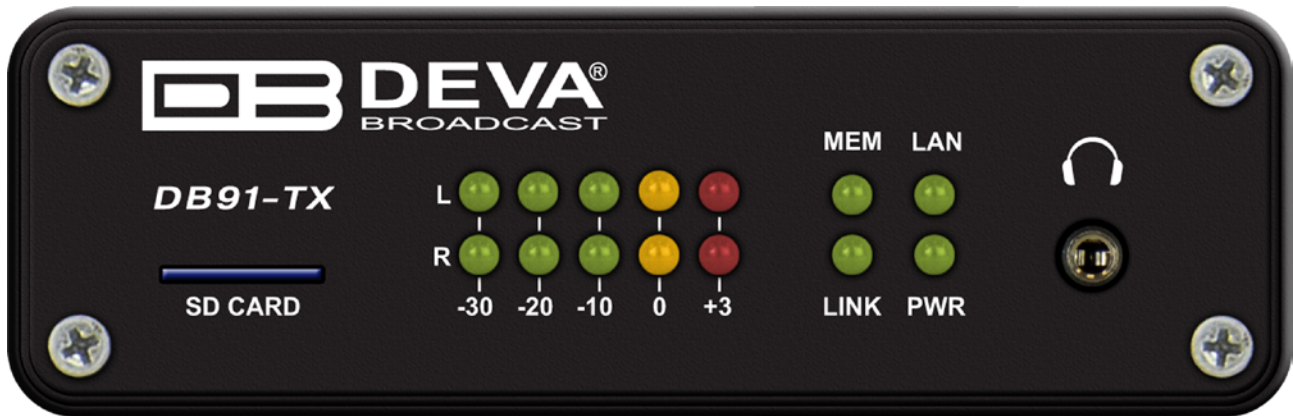

1. SD Card
2. L & R LED Meters – The full-time LED meters allow quick and easy monitoring of the Left and Right Audio channels.
3. MEM LED – microSD card status indicator.
4. LAN LED – Network status indicator
5. LINK LED – Connection status Indicator. This LED can be in one of the following states:
 - Off – NO active IP connection;
 - Blinking – at least one IP connection is active;
6. PWR LED Meter – Power LED Indicator
7. Phones Output – The following audio signals are reproduced through the headphones:
 - Voice Announcement of DB91-TX IP Audio Encoder's IP address upon startup;
 - Audio signal from the currently active audio source.

REAR PANEL



1. Power Supply (12 V, 1A);
2. Left Line Analog Output – standard RCA female jack;
3. Right Line Analog Output – standard RCA female jack;
4. Factory Defaults Reset button;
5. S/PDIF Output – standard RCA female jack;
6. LAN Port – standard RJ-45 port.

Block diagram

A simplified block diagram of DB91-TX IP Audio Encoder is shown below:

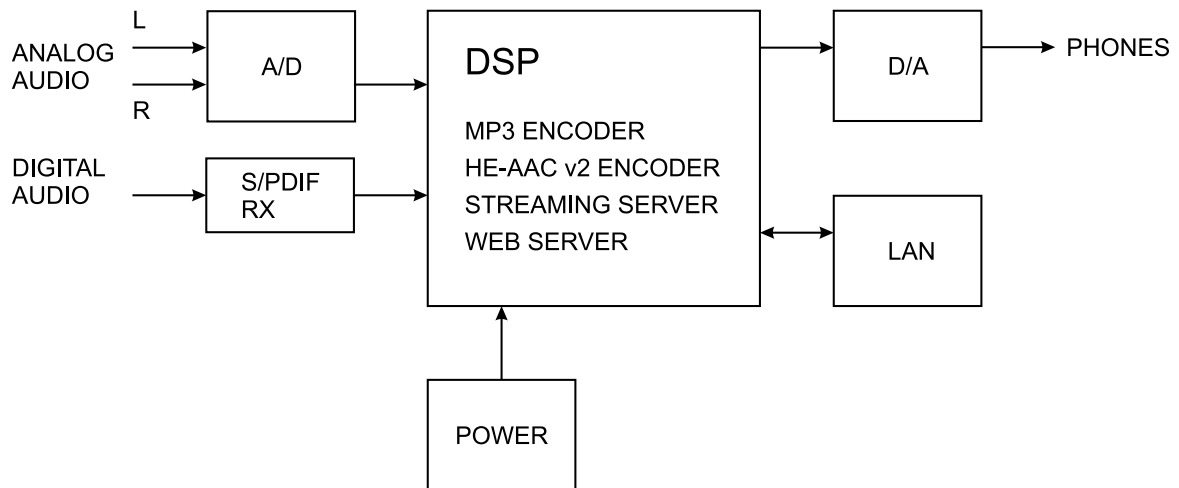

**NO USER-SERVICEABLE COMPONENTS INSIDE.
REFER ALL SERVICING TO QUALIFIED TECHNICAL PERSONNEL**

Before you start

SAFETY WARNING

- The servicing of electronic equipment should be performed only by qualified personnel;
- Before removing the covers DB91-TX must be switched off and the mains cable unplugged;
- When the equipment is open, the power supply capacitors should be discharged using a suitable resistor;
- Never touch the wires or the electrical circuits;
- Use insulated tools only;
- Never touch the metal semiconductor. They might carry high voltages;
- For removing and installing electronic components, follow the recommendations for handling MOS components.

ATTENTION: DB91-TX has an internal Lithium battery. Do not try to re-charge this battery! Please contact us for detailed instructions in case the battery should be changed.

OPERATING RECOMMENDATIONS

For normal operation of DB91-TX, we recommend following the instructions listed below.

- Install the unit in places with good air conditioning. DB91-TX is designed to operate within the ambient temperature range of 10 to 50°C. The equipment rack should be ventilated in order for the device to keep its internal temperature below the maximum ambient temperatures;
- We do not recommend installation in rooms with high humidity, dusty places or other aggressive conditions;
- Locate the device away from abnormally high RF fields;
- Use only checked power supply cables. We strongly recommend the usage of shielded cables;
- Connect DB91-TX only to reliable power supply sources. In case of unstable power supply, please use Uninterruptible Power Supply (UPS);
- Use the device only with its top cover on to avoid electromagnetic anomalies. Otherwise, this may cause problems with the normal functionality of the unit;
- For the normal remote operation of the unit, connect DB91-TX to a good quality Internet connection;
- For the normal operation of DB91-TX, check if the network settings pass through all the required data traffic.

UNPACKING AND INSPECTION

Upon receipt, the equipment should be inspected for possible shipping damages. If such are found or suspected, notify the carrier at once and contact DEVA Broadcast Ltd. The original shipping carton box and packing materials should be kept for possible reuse, in case of return for Warranty repair, for example. Shipping damages as a result of improper packing for return may *invalidate the Warranty!*

IT IS VERY IMPORTANT that the [“Product Registration Card”](#) included in the Manual be completed accurately and returned. This will assure coverage of the terms of the Warranty and it will provide a means of trace in case of lost or stolen equipment. In addition, the user will automatically receive SERVICE OR MODIFICATION INSTRUCTIONS from DEVA Broadcast Ltd.

Mounting

HEAT DISSIPATION

Having very low electricity consumption, the DB91-TX, itself generates negligible heat. The unit is intended for operation within an ambient temperature range, extending from freezing to 120°F/50°C. But because adjacent, less efficient equipment may radiate substantial heat, be sure that the equipment rack is adequately ventilated to keep its internal temperature below the specified maximum ambient.

RADIO FREQUENCY INTERFERENCE

Although we have made provision for DB91-TX, installation in the immediate proximity of broadcast transmitters, please do practice some care using the unit near abnormally high RF fields.

Basic Setup

ANALOG AUDIO INPUTS

Using a cable ending with two standard RCA jacks connect DB91-TX analog signal outputs to the analog audio inputs of your equipment.

WARNING: Do not exceed maximum input level. This may permanently damage the device.

DIGITAL AUDIO INPUTS

Using a cable ending with a standard RCA jacks connect the S/PDIF signal source to the digital audio input of DB91-TX.

NOTE: As only one input can be managed by the encoder at certain point of time, please select the preferred signal source input – either analog or digital one. Selecting the preferred input can be performed under CONFIGURATION menu ([see “Input” on page 20](#)).

LAN PORT

For normal operation it is necessary the device to be connected to a local network or Internet by cable with RJ-45 connector.

WEB Interface

DB91-TX is controlled through a built-in WEB Server and a standard web browser can be used to monitor its status or to make some adjustments. To operate the device you need to know its IP Address. In case you are not aware of it, you can hear it through the headphones when you turn on the device. Alternatively, use the Network discovery feature at Local networks. Then open a new WEB Browser and enter the device IP address in the address field then press [Enter].

NETWORK DISCOVERY

This is a network setting that defines whether your computer can see (find) other computers and devices on the network and whether other computers on the network can see your computer. By default, Windows Firewall blocks network discovery but you can enable it.

1. Open Advanced sharing settings by clicking the Start button, and then on “Control Panel”. In the search box, type “network”, click “Network and Sharing Center”, and then, in the left pane click “Change advanced sharing settings”;
2. Select your current network profile;
3. Click Turn on network discovery, and then click save changes.

NOTE: If you’re prompted for an administrator password or confirmation, type the password, provide confirmation or contact your system administrator.

If you have already enabled this function on your computer DB91-TX will be automatically added to the Device list section. The device will be ready for usage and no additional adjustments will be required except *user name* and *password*.

ACCESS

DB91-TX provides you with a protected access to the device settings. To make the necessary adjustments to the device, please log in as an ADMINISTRATOR. The default values being username: admin, password: pass.

WEB Interface Menu pages

STATUS

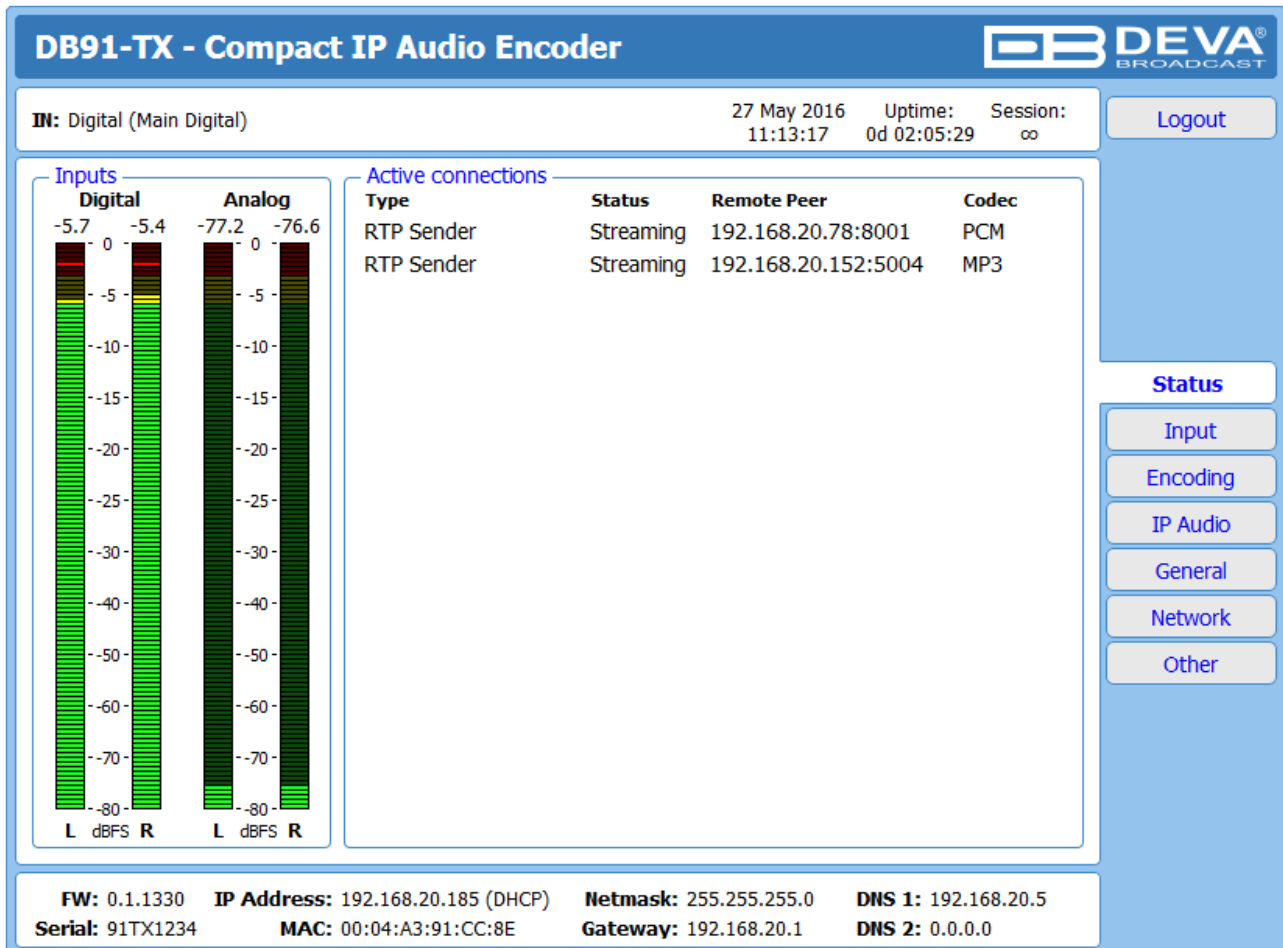

Upon opening the WEB interface, the main Status window will appear. The page contains information on the device's current status - the LED bar-graph representation of the left and right **Digital** and **Analog** audio levels in **dBFS**, as well as the **Active connections** - **Type**, **Status**, **Remote Peer** and **Codec**.

At the top of the control window is placed a constant section, containing information about the input in use, Date/Time and session timeout.

At the bottom of the control window is an information bar, gathering all the important connection parameters – firmware version in use, serial number, IP Address, and etc.

Upon change of the Web Interface screens, the main status window will resize automatically and become a constant part of each tab. Thus, allowing reading at a glance of all the mandatory parameters.

SETTINGS

DB91-TX - Compact IP Audio Encoder

IN: Digital (Main Digital) 27 May 2016 11:12:22 Uptime: 0d 02:04:33 Session: --:--

Inputs

Digital	Analog
-2.0	-77.1
0	-76.8
-10	
-20	
-30	
-50	
-70	

Active connections

Type	Status	Remote Peer	Codec
RTP Sender	Streaming	192.168.20.78:8001	PCM
RTP Sender	Streaming	192.168.20.152:5004	MP3

Welcome!

Username:

Password:

DB91-TX provides you with a protected access to the device settings. To make the necessary adjustments to the device, please log in as an ADMINISTRATOR. The default values being username: admin, password: pass.

INPUT

DB91-TX - Compact IP Audio Encoder Configuration

III: Digital (Main Digital)
27 May 2016 11:13:52
Uptime: 0d 02:06:03
Session: ∞
Logout

Inputs

Digital

-2.0 -2.0

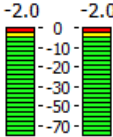

Analog

-77.1 -77.1

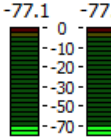

Active connections

Type	Status	Remote Peer	Codec
RTP Sender	Streaming	192.168.20.78:8001	PCM
RTP Sender	Streaming	192.168.20.152:5004	MP3

Input

Main: Digital

Backup: Analog

Digital Gain: 0.0 dB

Analog Gain: 3.0 dB

Audio Loss and Recovery

Loss Th.: -50.0 dB

Loss Tout: 10 s

Recover Th.: -50.0 dB

Recover Tout: 5 s

Headphones

Volume: 0.0 dB

Save

Status
Input
Encoding
IP Audio
General
Network
Other

Input – select analog or digital input to be used as Main or Backup audio source. It is not mandatory Backup input to be specified. An option **Not used** is also available from the drop down menu.

Headphones - the interactive slider allows you to control the volume of the headphones from -30dB to 0dB.

Audio Loss and Recovery – The conditions when backup source has to be used should also be specified (loss and recovery threshold and timeout).

NOTE: In order the applied settings to be used press the [Save] button, placed on the bottom right part of the screen.

If the Backup audio source is activated, the following message will appear on the main screen.

DB91-TX - Compact IP Audio Encoder

III: Analog (Main Analog)
02 Jun 2016 08:46:30
Uptime: 0d 00:03:32
Session: --:--

Inputs

Digital

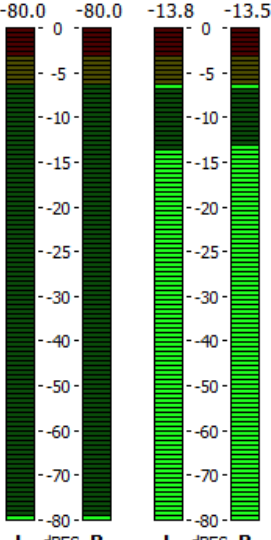

L dBFS R

Analog

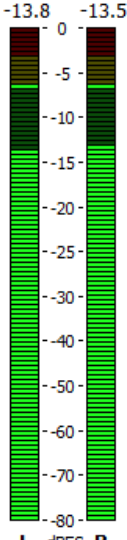

L dBFS R

Active connections

Type	Status	Remote Peer	Codec
RTP Sender	Streaming	192.168.20.78:8001	PCM
RTP Sender	Streaming	192.168.20.152:5004	MP3

[Status](#)
[Settings](#)

***** Backup Source is playing *****

FW: 0.1.1330	IP Address: 192.168.20.185 (DHCP)	Netmask: 255.255.255.0	DNS 1: 192.168.20.5
Serial: 91TX1234	MAC: 00:04:A3:91:CC:8E	Gateway: 192.168.20.1	DNS 2: 0.0.0.0

ENCODING

DB91-TX - Compact IP Audio Encoder Configuration

III: Digital (Main Digital)
27 May 2016 11:14:21
Uptime: 0d 02:06:32
Session: ∞
Logout

Inputs

Digital

-2.0 -2.0

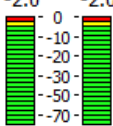

Analog

-78.0 -77.9

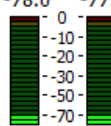

Active connections

Type	Status	Remote Peer	Codec
RTP Sender	Streaming	192.168.20.78:8001	PCM
RTP Sender	Streaming	192.168.20.152:5004	MP3

General

Sample rate:

Channels:

Encoder 1

Type:

Quality:

Stereo Mode:

CRC:

Emphasis:

Encoder 2

Type:

Quality:

Stereo Mode:

CRC:

Emphasis:

Bitrate Guide

Quality	Bitrate, kbps										
	MP3	HE-AAC				PCM (16-bit)					
		32 kHz	44.1 / 48 kHz		32 kHz		44.1 kHz		48 kHz		
	mono	stereo	mono	stereo	mono	stereo	mono	stereo	mono	stereo	
1	64	10	18	12	24	512	1024	706	1411	768	1536
2	96	12	20	18	36						
3	128	14	21	25	50						
4	192	16	22	31	62						
5	256	17	23	38	75						
6	320	18	24	44	88						

Save

Status

Input

Encoding

IP Audio

General

Network

Other

General – Specify Sample rate and Channels. These settings have influence on all codecs- PCM, Encoder 1 and Encoder 2.

IMPORTANT NOTE: As the only settings applicable to PCM are Sample rate and Channels, a specific section is not available. Quality does not apply to PCM stream. For PCM stream bitrate is calculated by the following equation: (sample rate)*(Number of channels)*16, [bps].

The settings applied to **Encoder 1** and **Encoder 2** are intended for MP3 and HE-AAC codecs. The applicable settings are explained in details below:

Encoder Type MP3

Type – select the encoder type.

Quality – Audio quality varies from 1 (Poor) to 6 (Excellent). Quality determines bitrate of the encoded stream. For MP3 encoded stream bitrate is independent of other parameters. For further information, refer to **Bitrate Guide** table. Please note all rates are in kbps.

Stereo mode – set the preferred mode from the drop-down menu. The following options are available: **Stereo, Joint Stereo, Dual channel** and **Single Channel**.

CRC – select whether MP3 stream should contain information on error detection.

Emphasis – select the emphasis to be applied. Supported values are 50 μ s, CCITT J.17.

Encoder Type HE-AAC

Type – select the encoder type.

Quality – As explained above, the audio quality varies from 1 (Poor) to 6 (Excellent). Quality determines bitrate of the encoded stream. For HE-AAC encoded stream bitrate depends on encoder version, number of channels and sample rate. For further information, refer to **Bitrate Guide** table. Please note all rates are in kbps.

Version – Select the preferred HE-AAC version from the drop-down menu.

NOTE: In order the applied settings to be used press the [Save] button, placed on the bottom right part of the screen.

IP AUDIO

DB91-TX - Compact IP Audio Encoder Configuration

III: Analog (Main Analog)
07 Dec 2016 10:18:05
Uptime: 0d 00:10:45
Session: ∞
Logout

Inputs

Digital

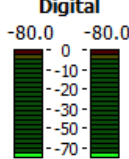

Analog

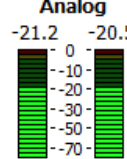

Active connections

Type	Status	Remote Peer	Codec
IP Audio Server	Streaming	192.168.20.187:56827	PCM

IP Audio Server

Encoder: PCM (16bit)

Port: 5000

Pre-buffer: 1.0 s

Max clients: 5

IP Audio Sender 1

Encoder: Encoder 1

Type: RTP Sender

Address:

Port: 5004

Payload type [▲] 0

[▲] 127 = Auto select payload type

IP Audio Sender 2

Encoder: Encoder 2

Type: Icecast Source Client

Address:

Port: 26988

Mount point:

User name:

Password:

IP Audio Sender 3

Encoder: PCM (16bit)

Type: SHOUTcast v1 Source

Address: live

Port: 28531

Password:

Status
Input
Encoding
IP Audio
General
Network
Other

Save

IP Audio Server

- Encoder – select the encoder to be used - **PCM (16bit)**, **Encoder 1** or **Encoder 2**.
- Port – specify the TCP port of the stream server. The default value is 5000.
- Pre-buffer – initial amount of data sent to the client. Large value decreases startup delay caused by buffering on the client side. This also introduces latency in the audio.
- Max clients – the maximum number of simultaneously connected clients. The maximum number of connections to be supported is 10. The default value is 5.

IP Audio Sender 1/2/3

DB91-TX has 3 multirole IP Audio senders. Each can be assigned to act as RTP Sender, Icecast Source Client or SHOUTcast v1 Source. To ensure more flexibility, the 3 IP Audio senders can use any of the available audio codecs. Depending on the currently selected *Type*, different set of settings should be applied:

RTP Sender Settings

If DB91-TX is used as a RTP Sender, the decoders' Server Address and Port should be filled in the respective fields:

- Address – URL or IP Address of the RTP Receiver.
- Port – UDP port of the RTP Receiver.
- Payload type – Allows specific payload type to be set in order for the receiver to recognize it. If 127 is set as value, the DB91-TX will set payload type based on the codec.

The RTP sender supports multicast streaming. In this mode Multicast Group address should be entered in the Address field.

Icecast Source Client Settings

If DB91-TX is used as an Icecast Source Mount point, Encoder IP Address and Port should be filled in. The username and password are used to secure the connection. Make sure to enter the same information on both sides of the connection.

- Address – URL or IP Address of the Icecast Distribution Server;
- Port – TCP port of the Icecast Distribution Server;
- Mount point – is a unique name on your server identifying a particular stream. A listener can only listen to a single mount point at a time. This means you can have a single Icecast server contain either multiple broadcasts with different content, or possibly the same broadcast but with streams of different bitrates or qualities. In this case each broadcast or stream is a separate mount point.
- Username – Username for Authentication with Icecast Receiver.
- Password – Password for Authentication with Icecast Receiver.

SHOUTcast Source Settings

If DB91-TX is used as a SHOUTcast v1 Source, Encoder IP Address and Port should be filled in. The password is used to secure the connection. Make sure to enter the same information on both sides of the connection.

NOTE: The selected encoder must match the settings of the decoders on the other side of the connection.

NOTE: In order the applied settings to be used press the [Save] button, placed on the bottom right part of the screen.

GENERAL

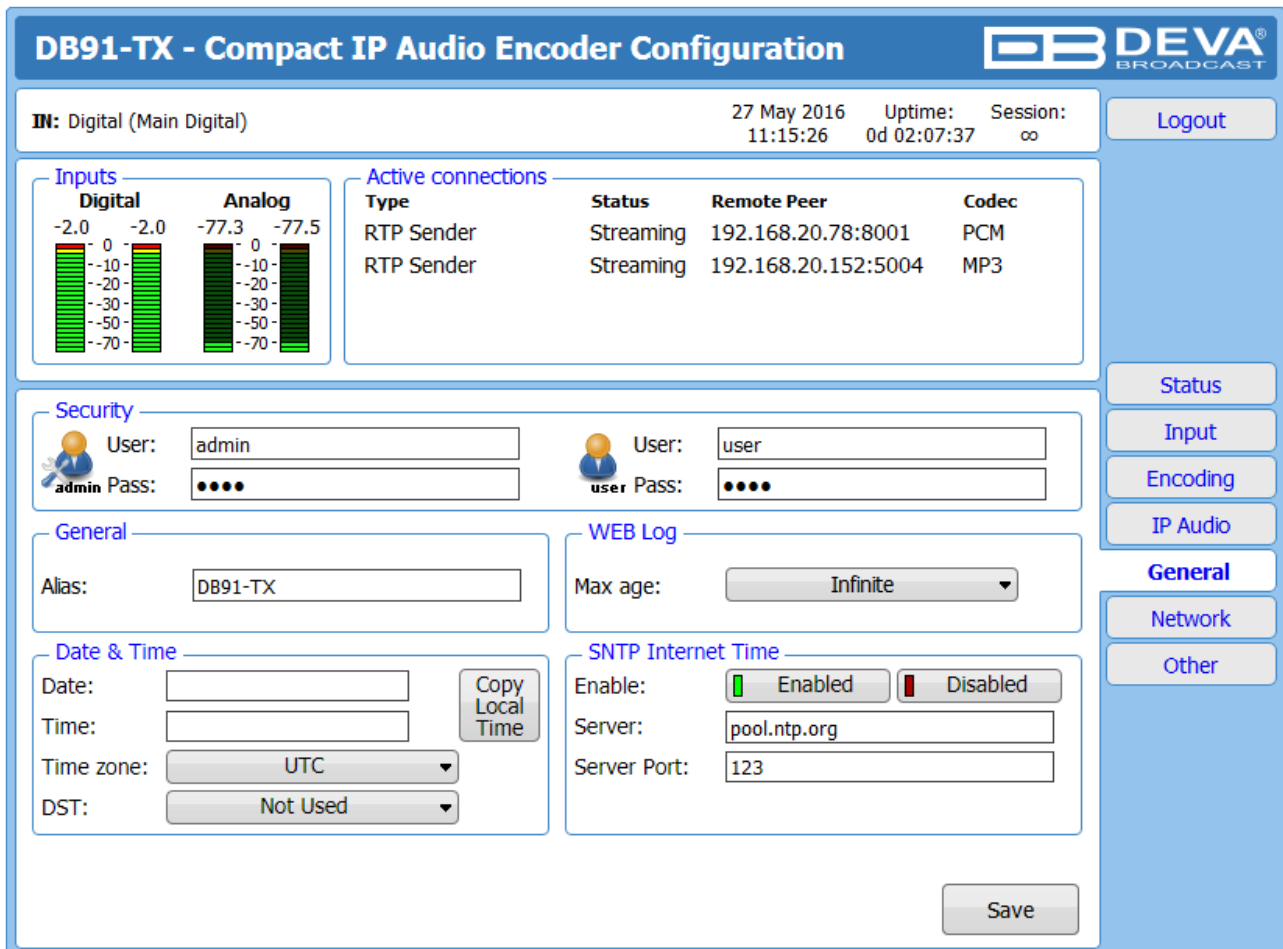

DB91-TX - Compact IP Audio Encoder Configuration

DEVA BROADCAST

III: Digital (Main Digital) 27 May 2016 Uptime: Session: Logout
 11:15:26 0d 02:07:37 ∞

Inputs

Digital **Analog**

-2.0 -2.0 -77.3 -77.5

0 0

-10 -10

-20 -20

-30 -30

-50 -50

-70 -70

Active connections

Type	Status	Remote Peer	Codec
RTP Sender	Streaming	192.168.20.78:8001	PCM
RTP Sender	Streaming	192.168.20.152:5004	MP3

Security

User: admin User: user
 Pass: ●●●● Pass: ●●●●

General

Alias: DB91-TX

WEB Log

Max age: Infinite

Date & Time

Date: Copy Local Time
 Time:
 Time zone: UTC
 DST: Not Used

SNTP Internet Time

Enable: Enabled Disabled
 Server: pool.ntp.org
 Server Port: 123

Save

DB91-TX provides you with protected access to the device settings. You can choose between two types of log in.

- As an ADMINISTRATOR – It will give you full control over the device’s settings;
- As a USER – that will allow you to just monitor the device, while all the settings remain locked.

In order for the security of DB91-TX to be enhanced, new username and password could be set from the Security section.

By choice, you can change the name of the device (General section). Later on, it will be used as a title name on all WEB pages. Customizing the name will make the device more recognizable.

Date & Time – used for manually determining the current Date and Time. [Copy Local Time] button will set the Date & Time to correspond to that of your computer.

SNTP Internet Time – Synchronizes automatically DB91-TX’s clock time with the Internet time server. Enable this function in order to use it (Specifying the server closest to your location will improve the accuracy).

WEB Log – the maximum storage time of the log files is chosen from here. Log files older than the specified will be permanently deleted.

NOTE: In order the applied settings to be used press the [Save] button, placed on the bottom right part of the screen.

NETWORK

DB91-TX - Compact IP Audio Encoder Configuration

III: Analog (Main Analog)
07 Dec 2016 12:46:54
Uptime: 0d 02:39:37
Session: ∞
Logout

Inputs

Digital

-80.0 -80.0

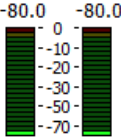

Analog

-20.7 -21.6

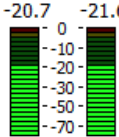

Active connections

Type	Status	Remote Peer	Codec
IP Audio Server	Streaming	192.168.20.187:56825	PCM

Network

Enable: Enabled

DHCP: Enabled Disabled

IP Address:

Netmask:

Gateway:

Primary DNS:

Sec. DNS:

HTTP Server

Enable: Enabled

Server Port:

Session time: min

FTP Server

Enable: Enabled Disabled

Cmd Port:

Data Port:

SNMP Agent

Agent: Enabled Disabled

Agent Port:

Agent ses. time: min

Agent ID:

Read Community:

Write Community:

Manager IP:

Manager Port:

SNMP MIB File:

E-mail

Enable: SMTP DEVA Disabled

E-mail 1:

E-mail 2:

E-mail account:

Username:

Password:

Host name:

Connection:

Server:

Server Port:

⚠ - These settings require reboot.

Status
Input
Encoding
IP Audio
General
Network
Other

Network

The network addresses could be set manually (static IP) or automatically via a DHCP Server. To set static *IP*, *MASK*, *GATEWAY* and *DNS* addresses, the *DHCP* should be disabled. In order for the built-in DHCP client to be activated, the function should be enabled. When the DHCP client is activated, all assigned values will be shown in the relevant fields on the “Status Screen”. If due to any reason, the DHCP procedure cannot be completed, DB91-TX will use Auto IP and will generate an IP Address.

E-mail

Enter the desired alarm recipients in *E-mail 1* and/or *E-mail 2* fields. Fill in your e-mail account settings: *Sender*, *Username* and *Password*, *Server*, *SNMP port* and *Connection Type*.

If you experience difficulties in the set-up, or would like to use DEVA account for sending of alarm email notifications, press the [DEVA] button option, and complete the recipient emails (E-mail 1 and E-mail 2) only. The other fields must be left blank, otherwise the email notification option will not be working. Event though using the DEVA account eases the set-up process, we recommend user account to be used for sending of email notifications, and the DEVA account for test purposes. When using DEVA account, please note that the stable 24/7 connection depends on the mail service provider and cannot be guaranteed.

We recommend you to use the [Test] button and generate a test e-mail, which upon success will be delivered to the specified *E-mail 1* and/or *E-mail 2*.

Example of Test E-mail Message:

DB91-TX Test Message.

Please do not reply to this e-mail.

HTTP Server

Enable/Disable the *HTTP Server*. Specify the *Server Port* and *Session Timeout*.

FTP Server

Enable/Disable the *FTP Server*. Specify the *Command* and *Data Ports* to be used.

For information on how the connection between the DB91-TX and an FTP Client should be configured, please [refer to “Download files via FTP” on page 32](#).

SNMP Agent

Specify *Agent ID*, *Agent Port*, *Read/Write Communities*, *Manager IP*, *Manager Port* and *Agent Session Time*.

Agent – enables/disables SNMP Agent.

Agent ID – is used for identification of the device among others, when an SNMP notification is being sent.

Once all needed settings are applied, use the Test button to generate a test notification, which upon success will be received by the SNMP Manager.

Press the [Download] button to download the latest available DB91-TX SNMP MIB file.

NOTE: The MIB file may vary from one firmware revision to another. Downloading this file from the device, guarantees that you have the proper MIB file.

OTHER

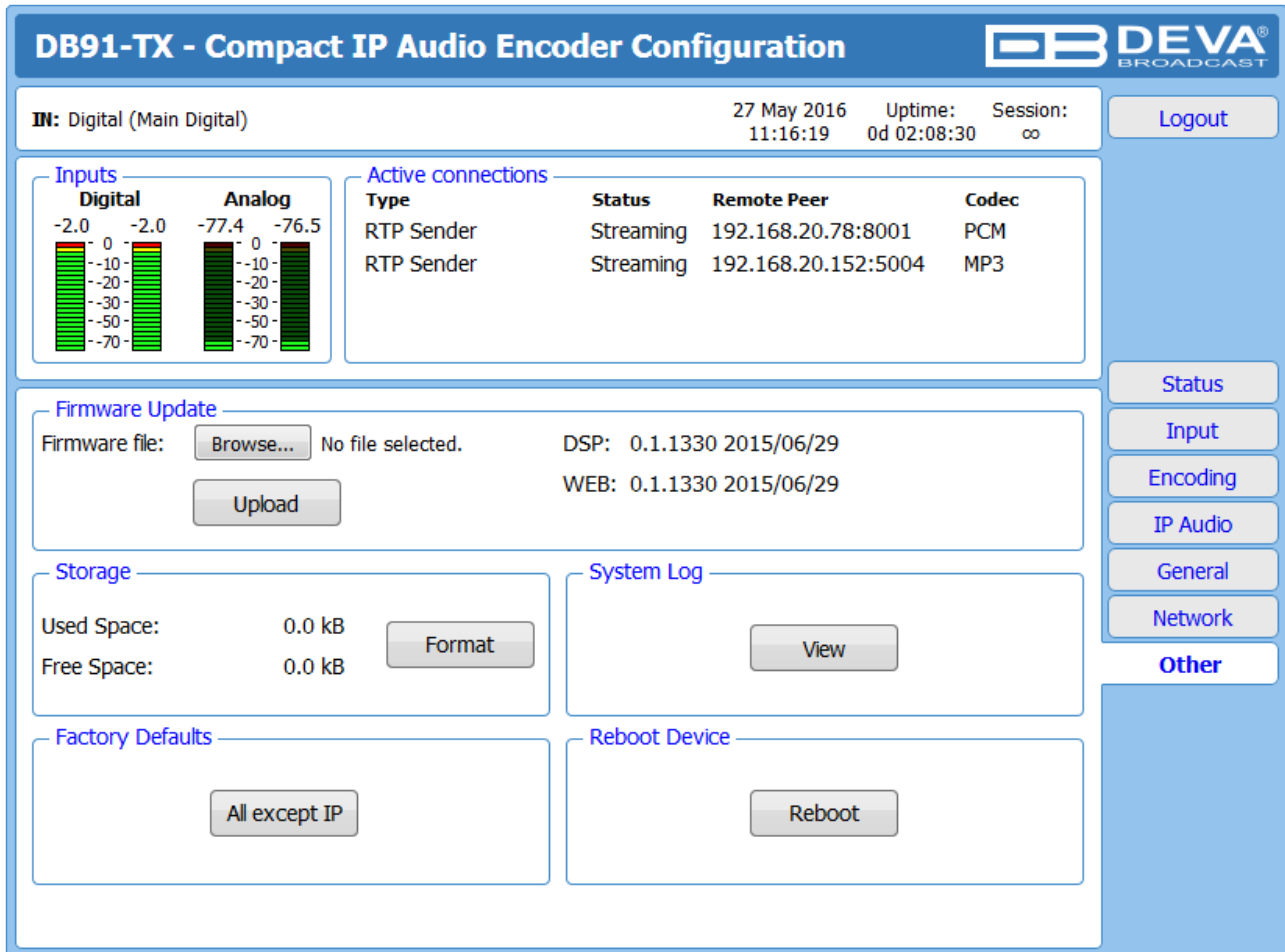

DB91-TX - Compact IP Audio Encoder Configuration

III: Digital (Main Digital) 27 May 2016 Uptime: Session:
 11:16:19 0d 02:08:30 ∞ Logout

Inputs

Digital **Analog**

-2.0 -2.0 -77.4 -76.5

0 0

-10 -10

-20 -20

-30 -30

-50 -50

-70 -70

Active connections

Type	Status	Remote Peer	Codec
RTP Sender	Streaming	192.168.20.78:8001	PCM
RTP Sender	Streaming	192.168.20.152:5004	MP3

Firmware Update

Firmware file: No file selected. DSP: 0.1.1330 2015/06/29
 WEB: 0.1.1330 2015/06/29

Storage

Used Space: 0.0 kB

Free Space: 0.0 kB

System Log

Factory Defaults

Reboot Device

Navigation sidebar: Status, Input, Encoding, IP Audio, General, Network, Other

Firmware Update

To update the device firmware, press [Browse] and select the new firmware file. After having pressed the [Upload] button, a dialog window will appear. Confirm the firmware update and wait for the process to complete.

Storage

Information about the device storage space is found in this section. The internal storage could be deleted by pressing the [Format] button.

Factory Defaults

[All except IP] – all settings except for the *Network settings* (IP addresses) will be deleted.

To restore DB91-TX to its factory defaults press the button. A new window will appear - confirm that you want to restore the factory defaults and wait for the process to be completed. On completion of the process, the settings should have the proper default values.

Reboot Device

To reboot the DB91-TX, press the [Reboot] button. A dialog warning window will appear. Confirm that you want to reboot the device and wait for the process to be completed.

System Log

By pressing the [View] button, a window with the following options will appear:

DB91-TX - Compact IP Audio Encoder Configuration

IN: Digital (Main Digital)
27 May 2016 11:16:19
Uptime: 0d 02:08:30
Session: ∞
Logout

Inputs

Digital

-2.0 -2.0

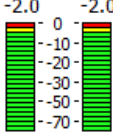

Analog

-77.4 -76.5

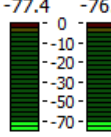

Active connections

Type	Status	Remote Peer	Codec
RTP Sender	Streaming	192.168.20.78:8001	PCM
RTP Sender	Streaming	192.168.20.152:5004	MP3

Time	Type	Message
2012-01-01 00:00:01	System	Storage init OK
2016-04-08 11:08:38	Control	WEB Login, 192.168.20.54, Admin
2016-04-08 11:11:56	Control	WEB Logout, 192.168.20.54
2000-01-02 05:02:17	System	Device is powered up
2012-01-01 00:00:01	System	Storage init OK
2016-04-08 13:16:53	Control	WEB Login, 192.168.20.54, Admin
2016-05-09 08:52:22	System	Device is running
2016-05-09 08:52:23	System	Storage init OK
2016-05-09 09:00:28	System	Device is running
2016-05-09 09:00:29	System	Storage init OK
2016-05-10 07:02:41	System	Device is running
2016-05-10 07:02:42	System	Storage init OK
2016-05-10 07:03:35	Control	WEB Login, 192.168.20.179, Admin
2016-05-10 10:19:29	Control	WEB Logout, 192.168.20.179
2016-05-10 10:20:03	Control	WEB Login, 192.168.20.35, Admin
2016-05-10 10:21:11	Control	WEB Logout, 192.168.20.35
2016-05-10 10:21:19	Control	WEB Login, 192.168.20.35, Admin
2016-05-10 10:22:36	Control	WEB Logout, 192.168.20.35
2016-05-10 10:22:42	Control	WEB Login, 192.168.20.35, Admin

Status
Input
Encoding
IP Audio
General
Network
Other

Pressing the [Clear] button will delete all recorded in the system log information.

Pressing the [Reload] button will update the displayed information.

HARDWARE RESET

This process will fully restore DB91-TX to its Factory Defaults, including the Network settings. Hardware Reset can be done by following the next steps:

1. Disconnect the power supply cable from the unit;
2. Locate the RESET button on Rear panel;
3. Press and hold the RESET button;
4. Connect the power supply cable to the unit;
5. Keep the RESET button hold until the POWER led starts blinking;
6. Release the RESET button;
7. Wait for DB91-TX to reboot.

Upon completion of the process DB91-TX settings will have the following values:

Network Default Settings

- **DHCP:** enabled

WEB Server Default Settings

- **Port:** 80
- **Username:** user
- **Password:** pass

NOTE: Upon completion of the process, the DHCP Client is enabled, and the DB91-TX will obtain IP Address from DHCP server shortly.

ATTENTION: Please note that the WEB Server's Port, Username and Password will be changed, so it is possible the page not to be loaded after restoring factory defaults. You may be asked to re-enter the encoder's address and/or username and password.

APPENDIX A

HOW SHOULD I CONFIGURE THE CONNECTION BETWEEN MY DEVA DEVICE AND AN FTP CLIENT?

In order for a connection to be established the following setting should be applied:

1. FTP Server Settings

The built-in FTP Server has four important parameters that should be configured: Command Port, Data Port, User name and Password. These parameters are to be used in the FTP client's connection configuration. Further information on how to change the FTP Server's settings and their respective default values can be found in the device's User manual.

WE RECOMMEND the usage of FileZilla (<https://filezilla-project.org>). This is a widespread open source software distributed free of charge, hence available for downloading from the Internet.

NOTE: The FTP Server can manage only one connection at a time. The FTP Server works in Passive mode. Hence, the FTP Client should also be set in passive mode.

2. IP Router and Port Translation Settings

If the connection to the device is made through a Network address translation (NAT) router or firewall, the port forwarding feature of the router should be configured. The port forwarding is usually set in the firewall section of the router's menu. As each router has different port forwarding procedure, we recommend you to refer to its complete manual. To allow proper data flow through the router, the FTP Command and FTP Data ports should be open.

NOTE: The FTP port numbers to be used in the port forwarding feature configuration can be found in the device.

3. Example of FTP Client (FileZilla) Settings

In some cases, FileZilla's "Quick connect" feature is not able to connect with the DEVA unit. That is why we recommend the device to be assigned in the program manually.

Enter the FTP Client and go to: **File > Site manager > New Site**. A dialog box requiring obligatory information about the device will appear. Fill in the needed information and press "OK".

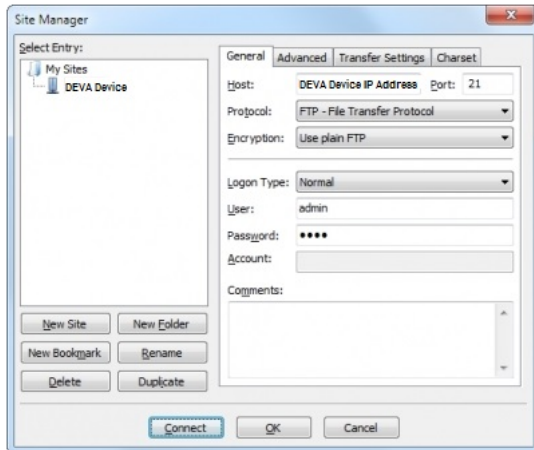

Select "Transfer Settings" sub-menu and apply the settings as shown below:

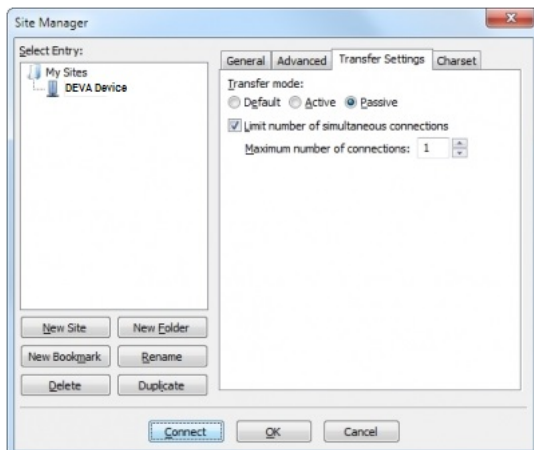

WARRANTY TERMS AND CONDITIONS

I. TERMS OF SALE: DEVA Broadcast Ltd. products are sold with an understanding of “full satisfaction”; that is, full credit or refund will be issued for products sold as new if returned to the point of purchase within 30 days following their receipt, provided that they are returned complete and in an “as received” condition.

II. CONDITIONS OF WARRANTY: The following terms apply unless amended in writing by DEVA Broadcast Ltd.

A. The Warranty Registration Card supplied with this product must be completed and returned to DEVA Broadcast Ltd. within 10 days of delivery.

B. This Warranty applies only to products sold “as new.” It is extended only to the original end-user and may not be transferred or assigned without prior written approval by DEVA Broadcast Ltd.

C. This Warranty does not apply to damage caused by improper mains settings and/or power supply.

D. This Warranty does not apply to damage caused by misuse, abuse, accident or neglect. This Warranty is voided by unauthorized attempts at repair or modification, or if the serial identification label has been removed or altered.

III. TERMS OF WARRANTY: DEVA Broadcast Ltd. products are warranted to be free from defects in materials and workmanship.

A. Any discrepancies noted within TWO YEARS of the date of delivery will be repaired free of charge, or the equipment will be replaced with a new or remanufactured product at DEVA Broadcast Ltd. option.

B. Parts and labor for factory repair required after the two-year Warranty period will be billed at prevailing prices and rates.

IV. RETURNING GOODS FOR FACTORY REPAIR:

A. Equipment will not be accepted for Warranty or other repair without a Return Authorization (RA) number issued by DEVA Broadcast Ltd. prior to its return. An RA number may be obtained by calling the factory. The number should be prominently marked on the outside of the shipping carton.

B. Equipment must be shipped prepaid to DEVA Broadcast Ltd.. Shipping charges will be reimbursed for valid Warranty claims. Damage sustained as a result of improper packing for return to the factory is not covered under terms of the Warranty and may occasion additional charges.

PRODUCT REGISTRATION CARD

- All fields are required, or warranty registration is invalid and void

Your Company Name _____

Contact _____

Address Line 1 _____

Address Line 2 _____

City _____

State/Province _____ ZIP/Postal Code _____

Country _____

E-mail _____ Phone _____ Fax _____

Which DEVA Broadcast Ltd. product did you purchase? _____

Product Serial # _____

Purchase date ____ / ____ / ____

Installation date ____ / ____ / ____

Your signature*

*Signing this warranty registration form you are stating that all the information provided to DEVA Broadcast Ltd. are truth and correct. DEVA Broadcast Ltd. declines any responsibility for the provided information that could result in an immediate loss of warranty for the above specified product(s).

Privacy statement: DEVA Broadcast Ltd. will not share the personal information you provide on this card with any other parties.