

# Converter Product Line Catalog

2010



Because it matters.



# Product Breakout Chart

	8-Bit	10-Bit	RGB Output	RGB Input	Component YpPr/RGB to SDI	Composite Y/C NTSC/PAL to SDI	SDI to YpPr/RGB Component	SDI to NTSC/PAL Component	SDI to SDI Loop	Frame Sync/FSG Option	HD-SDI to HD YpPr/RGB	HD YpPr/RGB to HD-SDI	HD-SDI to HD-SDI DA	SDI to SDI YpPr/RGB/V/C	HD-SDI to SDI	Dual Rate	Audio Embed/Disembed	Audio Conversion	Audio Reference Generator	Passes Audio To Output(s)	+5 to +18Vdc	HDMI	3G/HD/SD-SDI to Fibre	Fibre to 3G/HD/SD-SDI
D4E	•																							
D5CE	•		•				•	•	•															
D5D	•						•																	
D5PSW	•	•																						
D10AD	•	•		•	•	•																		
D10A	•	•		•	•																			
D10C	•	•	•				•	•	•															
D10C2	•	•	•				•	•	•															
D10CE	•	•	•				•	•	•															
D10CEA	•	•	•				•	•	•								•			•				
D5DA	•	•																		•				
R44E	•																							
R5CE	•		•				•	•	•															
RD5CE	•		•				•	•	•															
R10CE	•	•	•				•	•	•															
R20AD	•	•		•	•	•				•														
R20CE	•	•	•				•	•	•	•														
R20DA	•	•																						•
RD20DA	•	•																						•
RH10MD	•	•	•				•	•	•			•	•		•	•								•
RD10MD	•	•					•	•	•			•	•		•	•								•
RH10DA	•	•										•	•		•	•								•
RH10UC	•	•										•	•		•	•								•
FS1	•	•	•		•	•	•	•	•	•	•	•	•	•	•	•	•	•	•	•	•	•	•	•
3GM	•	•											•											
3GDA	•	•										•												
ADA4																			•	•	•	•	•	•
HD10C2	•	•	•				•	•	•		•	•												•
HD10A	•	•		•	•							•												
HD10AVA	•	•		•	•	•						•												•
HD10AM																								•
HD10AMA																								•
HD10CEA	•	•	•				•	•	•			•												•
HD10MD3	•	•	•				•	•	•			•	•		•	•								•
HD5DA	•	•										•												•
HD10DA	•	•										•												•
HDP2	•	•											•											•
Hi5	•																							•
Hi5-3G	•	•		•																				•
HA5	•																							•
GEN10																								•
FiDO-R	•	•															•							•
FiDO-2R	•	•															•							•
FiDO-T	•	•							•								•							•
FiDO-2T	•	•															•							•
FiDO-TR	•	•															•							•

<b>Product Breakout Chart</b>	<b>1</b>
<b>FS1 Universal SD/HD Audio/Video Frame Synchronizer and Converter, 1 RU</b>	<b>4</b>
<b>KUMO Compact SDI Routers and Optional Remote Control Panel (new)</b>	<b>6</b>
<b>FIDO SDI/Optical Fiber Converters (new)</b>	<b>10</b>
<ul style="list-style-type: none"> <li>• <a href="#">FIDO-R</a> Single Channel Fiber to SDI Converter with Dual SDI Outputs</li> <li>• <a href="#">FIDO-2R</a> Dual Channel Fiber to SDI Converter</li> <li>• <a href="#">FIDO-T</a> Single Channel SDI to Fiber Converter with Looping SDI Output</li> <li>• <a href="#">FIDO-2T</a> Dual Channel SDI to Fiber Converter</li> <li>• <a href="#">FIDO-TR</a> SDI/Fiber Transceiver</li> </ul>	<ul style="list-style-type: none"> <li>10</li> <li>10</li> <li>10</li> <li>10</li> <li>10</li> </ul>
<b>HD-Series High Definition Mini Converters</b>	<b>12</b>
<ul style="list-style-type: none"> <li>• <a href="#">3GM</a> 3G/1.5G HD-SDI Multiplexer</li> <li>• <a href="#">3GDA</a> 1x6 3G/HD/SD Reclocking Distribution Amplifier</li> <li>• <a href="#">GEN10</a> HD/SD Sync Generator</li> <li>• <a href="#">HD10C2</a> HD-SDI and SDI Digital to Analog Converter</li> <li>• <a href="#">HD10MD3</a> HD-SDI to SDI/Analog Downconverter</li> <li>• <a href="#">HD10A</a> HD Analog to HD-SDI Converter</li> <li>• <a href="#">HD10CEA</a> HD/SD-SDI to Analog Audio/Video Converter, 10-bit</li> <li>• <a href="#">HD10AVA</a> HD/SD-SDI Analog Composite or Component Video and 4 Ch Analog Audio to SD/HD-SDI w/Embedded Audio</li> <li>• <a href="#">HD10DA</a> 1x6 HD/SD-SDI Distribution Amplifier</li> <li>• <a href="#">HD5DA</a> 1x4 HD-SDI Distribution Amplifier</li> <li>• <a href="#">HD10AMA</a> HD/SD-SDI 4 Channel Analog Embedder/Disembedder</li> <li>• <a href="#">HD10AM</a> HD/SD-SDI 8 Channel AES Embedder/Disembedder</li> <li>• <a href="#">ADA4</a> 4 Channel Bi-directional Audio A/D and D/A Converter</li> <li>• <a href="#">HDP2</a> HD/SD-SDI To DVH-D Video And Audio Converter</li> <li>• <a href="#">HA5</a> HDMI To HD/SD-SDI Video And Audio Converter</li> <li>• <a href="#">HI5</a> HD/SD-SDI To HDMI Video And Audio Converter</li> <li>• <a href="#">HI5-3G</a> 3G/Dual-link/HD/SD-SDI To HDMI 1.3a Video and Audio Converter</li> </ul>	<ul style="list-style-type: none"> <li>12</li> <li>12</li> <li>13</li> <li>13</li> <li>14</li> <li>14</li> <li>15</li> <li>15</li> <li>16</li> <li>16</li> <li>17</li> <li>17</li> <li>18</li> <li>18</li> <li>19</li> <li>19</li> <li>20</li> </ul>
<b>D-Series Min Converters</b>	<b>20</b>
<ul style="list-style-type: none"> <li>• <a href="#">D10CE</a> SDI to Simultaneous Component and Composite Analog Converter, 10-bit</li> <li>• <a href="#">D10C2</a> SDI to Component or Composite Analog Converter, 10-bit</li> <li>• <a href="#">D10CEA</a> SDI to Analog Audio and Video Converter, 10-bit</li> <li>• <a href="#">D10C</a> Composite Digital (D2/D3) to Composite Analog, or SDI to YPbPr or RGB Converter, 10-bit</li> <li>• <a href="#">D10AD</a> Component or Composite Analog to SDI Converter, 10-bit</li> <li>• <a href="#">D10A</a> Component to SDI Converter (with Separate Sync Input)</li> <li>• <a href="#">D5D</a> Composite and S-Video Analog to SDI Converter</li> <li>• <a href="#">D5CE</a> SDI to Component or Composite Analog Converter</li> <li>• <a href="#">D4E</a> SDI to Composite Analog Converter</li> <li>• <a href="#">D5DA</a> 1x4 SDI Distribution Amplifier, Multi-format</li> <li>• <a href="#">D5PSW</a> SDI Protection Switch</li> <li>• <a href="#">DWP</a> 110V Power Supply</li> <li>• <a href="#">DWP-U</a> Universal Power Supply</li> <li>• <a href="#">RMB</a> and <a href="#">RMB-10</a> Rack Mounting Brackets for D- and H-Series Converters (new)</li> </ul>	<ul style="list-style-type: none"> <li>20</li> <li>21</li> <li>21</li> <li>22</li> <li>22</li> <li>23</li> <li>23</li> <li>24</li> <li>24</li> <li>25</li> <li>25</li> <li>26</li> <li>26</li> <li>26</li> </ul>
<b>R-Series Rackmount Interface Cards and Frames</b>	<b>26</b>
<ul style="list-style-type: none"> <li>• <a href="#">FR1</a> One RU Rack Mount Frame and Power Supply, 4-Slot</li> <li>• <a href="#">FR2</a> Two RU Rack Mount Frame and Power Supply, 10-Slot</li> <li>• <a href="#">RH10UC</a> SDI to HD-SDI Upconverter and HD Frame Synchronizer, 10-bit</li> <li>• <a href="#">RH10MD</a> High Definition Downconverter and 1x4 HD-SDI DA, 10-bit</li> <li>• <a href="#">RD10MD</a> Dual HD to SD Downconverter, 10-bit</li> <li>• <a href="#">RH10DA</a> Dual Rate HD/SD-SDI 1x8 Re-clocking Distribution Amplifier</li> <li>• <a href="#">R20DA</a> 1x8 SD-SDI Distribution Amplifier, Multi-format</li> <li>• <a href="#">R20AD</a> Component or Composite Analog to SD-SDI Converter, 10-bit</li> <li>• <a href="#">R20CE</a> SD-SDI to Component and Composite Analog Converter, 10-bit</li> <li>• <a href="#">FSG</a> Frame Sync, Genlock Module (R20AD &amp; R20CE Only)</li> <li>• <a href="#">R10CE</a> 1x4 SD-SDI DA and 10-bit Component/Composite Analog Converter</li> <li>• <a href="#">R5CE</a> 1x4 SD-SDI DA and Component/Composite Analog Converter</li> <li>• <a href="#">RD5CE</a> Two Channel SD-SDI to Component/Composite Analog Converter</li> <li>• <a href="#">RD20DA</a> Dual Channel SD-SDI Distribution Amplifier</li> <li>• <a href="#">R44E</a> Four Channel SD-SDI to Composite Analog Converter</li> </ul>	<ul style="list-style-type: none"> <li>26</li> <li>27</li> <li>27</li> <li>28</li> <li>28</li> <li>29</li> <li>29</li> <li>30</li> <li>30</li> <li>31</li> <li>31</li> <li>32</li> <li>32</li> <li>33</li> <li>33</li> </ul>
<b>C-Series Parallel/Serial Converters</b>	<b>10</b>
<ul style="list-style-type: none"> <li>• <a href="#">C-Series</a> Parallel/Serial Converters</li> <li>• <a href="#">C-Series</a> Power Supplies</li> </ul>	<ul style="list-style-type: none"> <li>34</li> <li>34</li> </ul>

# FS1



Featuring a flexible “anything in, anything out” architecture, the FS1 can simultaneously work with both HD and SD video – all in full 10-bit Broadcast quality video and 24-bit audio. The FS1 supports virtually any input or output, analog or digital, HD or SD. The FS-1 can up- or down-convert between SD and HD, and provide simultaneous HD and SD outputs. Cross-conversions between HD formats are also supported, with simultaneous output of both formats. For audio, the FS1 supports 8-channel AES, Balanced analog, or 16 channel embedded audio with full flexibility. The FS1 supports closed captioning and the conversion of closed captioning between SD and HD formats – including full conversion of CEA-608 captions to the CEA-708 standard. The FS-1 is also network ready, supporting SNMP monitoring and web-based remote control. Optional Remote Control Panel is available from a 3rd-party (contact your AJA dealer—or AJA directly for more information).



Front



Rear



## Remote Web Interface



Input	Possible Output Formats		
525i59.94	525i59.94	720p59.94	1080i59.94
720p59.94	525i59.94	720p59.94	1080i59.94
1080i59.94	525i59.94	720p59.94	1080i59.94
1080pSF23.98	1080pSF23.98	1080i59.94	525i59.94
625i50	625i50	1080i50	720p50
720p50	625i50	1080i50	720p50
1080i50	625i50	1080i50	720p50
1080pSF24	1080pSF24	1080i60	
1080i60	1080i60	720p60	
720p60	720p60	1080i60	

### Notes

- In the case of 1080pSF/23.98 input – and when 1080i59.94 (or 525) is selected as an output format, the FS1 automatically does 3:2 pulldown to get the correct frame. Similarly, in the case of 1080pSF/24 input, FS1 automatically does 3:2 pulldown to get the correct frame rate.
- When passing 24 or 60 framerate video, outputs are high definition.

## Features

- Universal HD/SD Audio/Video Frame Synchronizer and Converter
- SD<->HD up/down conversion
- SD<->SD aspect ratio conversion
- HD<->HD cross conversion (720p/1080i)
- Dual HD/SD SDI Inputs and Outputs
- Component Analog HD/SD I/O
- Composite/S Video I/O with TBC
- 8 Channel AES and Balanced Analog Audio inputs and outputs
- 16 Channel Embedded Audio I/O
- Redundant Power Supplies Standard
- 10/100 LAN with DHCP, SNMP and Embedded Web Server for Remote Control
- Sidebar Keyer
- Front Panel Lockout from Web UI
- Password Protect for Web UI
- Video Proc Amp
- Audio Processor
- Closed Caption Support – Up/Down/ Cross Conversion
- Audio Channel Mapping
- Active Format Description (AFD)
- 5 Year Warranty

## Specifications

### Video Inputs and Outputs:

- Dual HD/SD-SDI, SMPTE 259/274/292/296
- HD component YPbPr/RGB (RGB is output only), SMPTE-274
- SD component/composite/YC (S Video)

### Video A/D, D/A:

- 12-bit
- 2x oversampled (HD)
- 4x oversampled (SD)

### Audio Inputs and Outputs:

- 8 Channel Balanced, 25 pin D (Tascam pinout)
- 8 Channel AES (BNC)
- 32 Input Channel Mapping
- 16 Channel HD/SD-SDI Embedded

### Audio A/D, D/A:

- 24-bit, 48Khz

### Audio levels:

- +12dBu • +15dBu • +18dBu • +24dBu • (Full Scale Digital)

### LAN:

- 10/100 auto config • auto cable crossover
- Embedded Webserver
- HTTP v1.1

### GPI:

- 2x GPI input, TTL, isolated
- 2x GPI output, TTL, isolated

### Physical:

- 1 RU • 12 inches deep • fan cooled

### Power:

- 100-240 VAC • 25 watts Fully Redundant • diode isolated

# KUMO

## Compact SDI Routers

NEW

**1616**  
Rear Panel



**1604**  
Rear Panel



KUMO compact SDI routers are small and cost-effective, yet robust and reliable. KUMO supports full broadcast specifications over SDI, HD-SDI, and 3G SDI. KUMO routers are a perfect fit for any broadcast, production, or post production environment. Running Embedded Linux, KUMO routers are network ready and support powerful HTTP control and monitoring. KUMO's internal webserver allows immediate installation, configuration, and operation with standard web browsers - without any additional software to buy or install. An optional 1RU networkable control panel (KUMO CP) can be used in stand-alone or networked configurations.

KUMO SDI routers are available in two configurations: the KUMO 1604 supporting sixteen SDI inputs and four outputs, and the KUMO 1616 supporting sixteen channels in and out. Because of their compact 1RU size, KUMO SDI routers are ideal for space-sensitive applications such as mobile sports trucks, edit suites, corporate video installations, or live theatrical A/V rigs. KUMO compact SDI routers offer AJA-reliability, flexibility and state-of-the-art signal quality, while delivering it for an unprecedented price.



Optional KUMO Remote Control Panel (KUMO CP)

### Remote Web Interface



- Tabbed screens make navigation a snap
- Source Selection
- Destination Selection

## Connections

**KUMO 1616**

**3G/HD/SD-SDI Inputs and Outputs**  
• All inputs and outputs, 3G, HD-SDI, or SD-SDI (SMPTE 259M/292M/424M)

**KUMO 1604**

**Reference Video with Loop-Through**  
• Synchronize outputs to house reference video signal (blackburst or composite sync for SD, or Tri level for HD)

**LAN Connection**  
• RJ45 10/100/1000 LAN connector—internal webserver, Bonjour support

**Redundant Power Supply Inputs**  
• Two independent 12Vdc inputs provide safe operation. Power status can be checked from a LAN attached browser

**RS422**  
• RS422 remote control via 9-pin DB9 connector

## Simple Installation and Configuration—and Easily Scalable

Installation of KUMO Compact routers is easy: with Bonjour, network configuration is automatic—just connect KUMO to your network or a computer. Alternatively, standard network configuration is also easy—just connect KUMO to your network, or a computer, and access KUMO via its default IP address.

Once connected to KUMO using a web browser, you can configure the full TCP/IP settings, select and name KUMO routers, name sources and destinations, and perform all operational functions.

For stand-alone configurations of KUMO routers with KUMO CP control panels only, just connect the KUMO components together with standard RJ45 cables and an Ethernet switch (if needed).



KUMO and the Optional KUMO CP Both Support Bonjour

## Features

- SD, HD, 3G SDI inputs and outputs via BNC, SMPTE 259M/292M/424M
- Automatic EQ and re-clocking
- Supports all ancillary data, including embedded audio
- Reference via BNC, passive loop, PAL/NTSC color black or HD tri-sync
- 10/100/1000 Ethernet LAN
- Auto-detect Bonjour™/Zeroconf protocol provides ease of installation
- Embedded Linux OS with internal webserver for web browser control
- Control from HTTP or Remote Control Panel (KUMO CP is optional)
- 1RU form factor
- Redundant power inputs (isolated)
- 1 power supply and line cord supplied
- Optional power supply available
- AJA 5-year international warranty

## Specifications

### Formats:

- 3Gb, 1.5Gb, 270Mb, ASI, Auto Select

### Video Inputs and Outputs:

- SDI (SMPTE 259/292/296/424), BNC

### Cable Equalization (BNC inputs, 1694 coax):

- 270Mb: 400m
- 1.5Gb: 200m
- 3Gb: 140m

### Input/Output Return Loss (BNC):

- >15db, 270Mb – 1.5Gb
- >10db, 1.5Gb – 3Gb

### Reference Input:

- Analog input, passive looping BNCs
- Format: NTSC, PAL, Tri-level sync

### Control:

- 10/100/1000 Ethernet, RJ-45, internal Linux OS/web server
- RS-422 (future enhancement)

### Environment:

- Operating Temperature: 0 to 40 Degrees C
- Relative Humidity: 0 to 90%, non-condensing

### Power:

- +12 VDC nominal, 9-18VDC range, optional redundant power
- KUMO 1604: 9 watts
- KUMO 1616: 20 watts
- KUMO CP: 5 watts

### Size:

- KUMO 1604, 1616: 19" width x 1.75" height, x 1.5" depth (483 x 44.5 x 38.1 mm)
- KUMO RCP: 19" width x 1.75" height, x 1.3" depth (483 x 44.5 x 33 mm)

### Weight:

- KUMO 1616: 1.4 lb (.64 kg)
- KUMO 1604: 1.2 lb (.55 kg)
- KUMO CP: 1.2 lb (.55 kg)

# KUMO

## Compact SDI Routers

### Configuration Options

KUMO compact SDI routers not only offer innovative architectures, they excel at providing configuration and control flexibility. Because all KUMO products are networkable, they are easy to set up in a networked environment or in stand-alone configurations. For control you can use either a web browser or the optional KUMO Control Panel. KUMO Control Panels can be connected directly to KUMO routers or to the network. Easily scalable, KUMO systems can always expand as your needs do. Here are just some possible control scenarios:

- Stand-alone: up to 4 routers and 16 control panels can be set-up without ever connecting a computer. Just plug all the pieces into an Ethernet switch and power them up. KUMO auto-discovery software automatically assign routers to control panel delegations in a deterministic way, so you're ready to use the system immediately.
- Network - computer control only: an unlimited number of KUMOs can be configured, networked, and controlled by web browser(s) using industry standard TCP/IP networking.
- Hybrid Network – computer(s) and KUMO Control Panel(s): hybrid systems can be created where there are both KUMO Control Panels and computer web browsers providing router control.

Basic KUMO stand-alone routing systems—zero configuration, just plug, power, and play

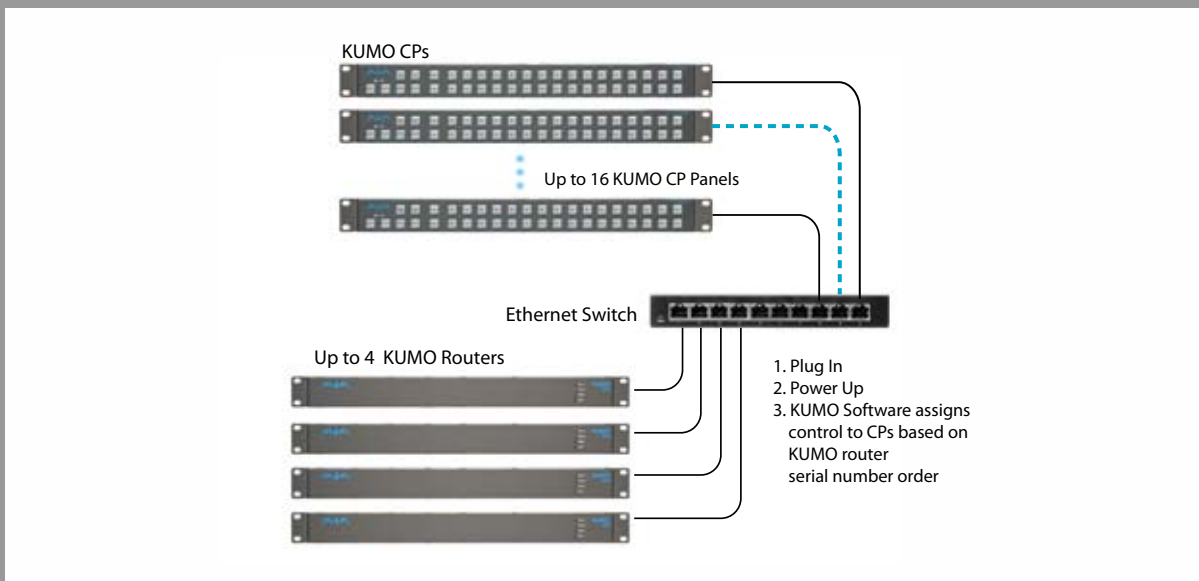



KUMO LAN-only System—use TCP/IP to configure routers and devices

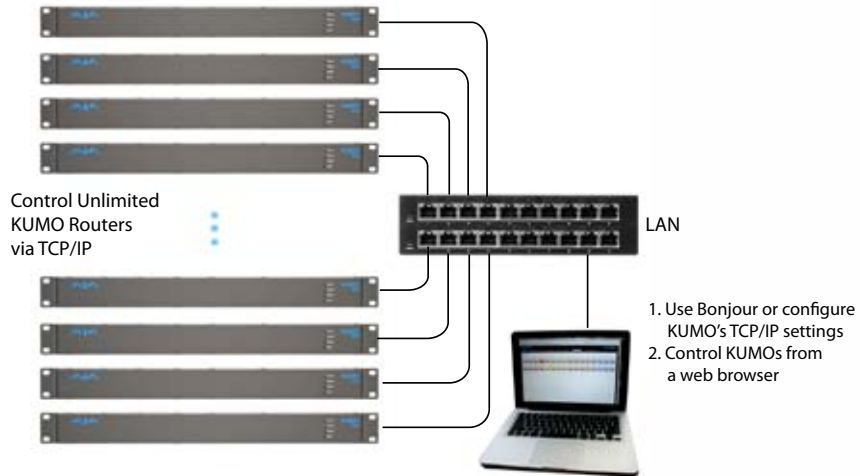

Hybrid System—KUMOs Controlled by KUMO CPs and Web Browsers

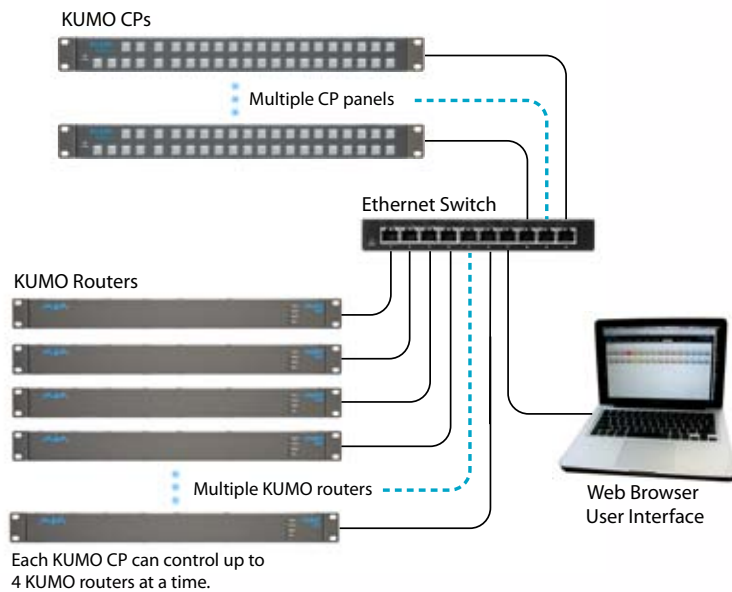

# FiDO

## SDI/Optical Fiber Converters

NEW

FiDO is a family of SDI/Optical Fiber converters. FiDO allows the transport of SDI, HD-SDI, and 3G SDI over distances up to 10km using standard single-mode fiber optic cable with LC connectors. FiDO converters meet all relevant SMPTE specifications and are rugged, versatile, and suitable for indoor or outdoor use.

With 5 models, FiDO offers unmatched flexibility and cost efficiency. FiDO dual channel models allow the conversion of 2 channels—perfect for 3D, dual-link SDI, or 2 completely independent SDI channels (for example, SD, HD, and 3G can be mixed in any combination). Also, FiDO converters offer electrical isolation useful for eliminating ground loop problems.

FiDO converters come in a compact, low-profile enclosure for use in tight spaces around and behind equipment racks, trucks and crowded facilities.



### FiDO Models

- FiDO-R: Single channel Fiber to SDI converter with dual SDI outputs
- FiDO-2R: Dual channel Fiber to SDI converter
- FiDO-T: Single channel SDI to Fiber converter with looping SDI output
- FiDO-2T: Dual channel SDI to Fiber converter
- FiDO-TR: SDI/Fiber transceiver

### Accessories

- DWP: Universal power supply (North American connector)
- DWP-U: Universal power supply (IEC-320 connector)
- Rack mount bracket
- 4 pin XLR power cable

**FiDO-T**  
Single Channel SDI to  
Fiber with Looping  
SDI Output

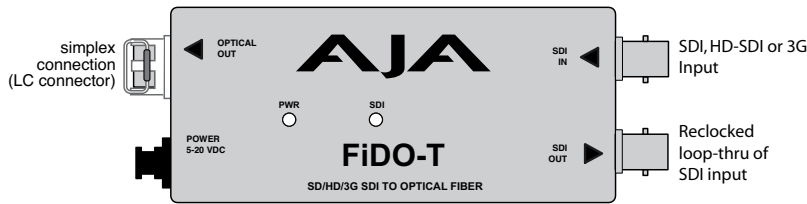

**FiDO-2T**  
Dual Channel SDI  
to Fiber

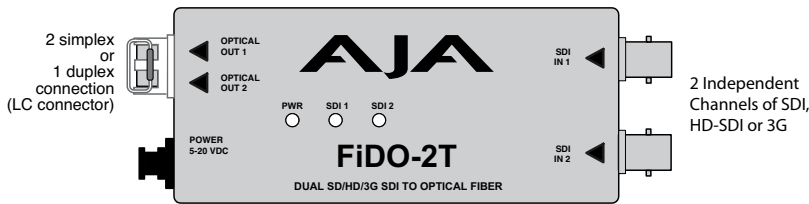

**FiDO-R**  
Single Channel Fiber  
to SDI with  
Dual SDI Outputs

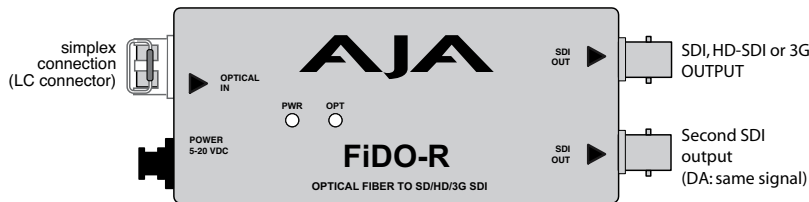

**FiDO-2R**  
Dual Channel Fiber  
to SDI

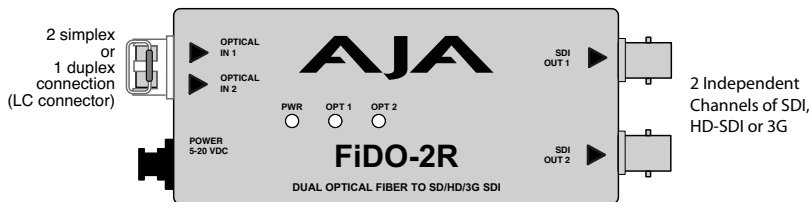

**FiDO-TR**  
SDI/Fiber  
Transceiver

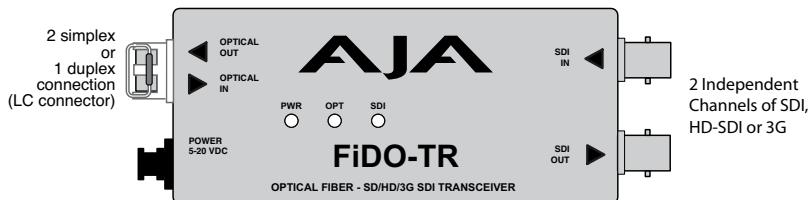

**Features**

- Transport of SDI, HD-SDI, and 3G HD-SDI over single mode optical fiber
- Auto-detection of video format
- All SDI Ancillary data including embedded audio is passed
- LC fiber connectors
- Simplex or duplex models available
- All inputs, either SDI or fiber, are equalized and re-clocked
- ASI compatible
- Useful for eliminating ground loop problems
- 5-20VDC power supply (sold separately)
- 5 year warranty

**Specifications**

**Formats:**

- 3Gb, 1.5Gb, 270Mb, Auto Select

**Video Inputs/Outputs:**

- SDI (SMPTE 259/292/296/424), 2x BNC
- 1 x Single mode optical fiber, LC connector (FiDO-R, FiDO-T)
- 2x Single mode optical fiber, LC connectors (FiDO-2R, FiDO-2T, FiDO-TR)

**Cable Equalization**

**(BNC inputs, 1694 coax):**

- 270mb, 400m
- 1.5Gb, 200m
- 3Gb, 140m

**Input/Output Return Loss (BNC):**

- >15db, 270Mb - 3Gb

**Optical Outputs:**

- Wavelength: 1310 nm
- Output Power: -2dBm typical

**Size:**

- 4.6" x 1.71" x .85" (117 x 43.5 x 21.6mm)

**Power:**

- +5-20 VDC
- 1.5 watts (FiDO-T, FiDO-R)
- 2.5 watts (FiDO-2R, FiDO-2T, FiDO-TR)
- Requires Power Supply (AJA power supply model DWP or DWP-U recommended)

## 3GM 3G/1.5G HD-SDI Multiplexer



The 3GM is versatile and economical tool for interconnecting dual-link 1.5G SMPTE372M and 3G SMPTE425M. 3GM is bi-directional - allowing dual 1.5G to 3G or 3G to dual 1.5G conversion. Additionally, 3GM's 3G HD-SDI output is configurable for SMPTE425M type A or B. The 3GM can even convert 3G from/to type A or B. 3GM also provides a monitor output which is a single link SMPTE292M 1.5G HD-SDI. The 3GM is also compatible with SMPTE259M 270Mb SDI.

### Features

- Compact 3G to/from 1.5G conversion
- SMPTE425M-AB inputs, 3G outputs configurable to A or B
- Converts SMPTE425M A to/from SMPTE425M B
- Provides SMPTE292 monitor output for dual 1.5G or 3G inputs
- Fully equalizing and re-clocking with jitter attenuation
- If SMPTE 292M is input, all outputs are 1.5G SMPTE 292M
- 5 Year Warranty

### Specifications

#### Formats:

- 3Gb, 1.5Gb, 270Mb Auto Select

#### Video Inputs::

- 2 HD-SDI, SDI (SMPTE 259/292/296/424), 2x BNC

#### Video Outputs:

- 3G HD-SDI, HD-SDI, SDI, 3x BNC

#### Return Loss:

- >15db to 3Gb

#### Size:

- 4.6" x 2.4" x 1" (117 x 61 x 25mm)

#### Power:

- +5VDC Regulated, 4 Watts, Requires Power Supply

## 3GDA 1x6 3G/HD/SD Reclocking Distribution Amplifier



The 3GDA is a miniature, low-cost 1x6 3G/HD/SD-SDI input, re-clocking distribution amplifier. Featuring six separately buffered SDI outputs, the 3GDA provides automatic input detection, re-clocking and cable equalization.

### Features

- Compact SD/HD Distribution
- Six Separately Buffered Outputs
- Miniature Size
- 3G cable equalization (1694 coax)
- SD: 270mb, 350m, HD: 1.5Gb, 200m
- 3G/HD/SD-SDI input, auto sensing
- Passes all ancillary data
- +5-18V power supply
- 5 Year Warranty

### Specifications

#### Formats:

- 3Gb, 1.5Gb, 270Mb Auto Select

#### Video Inputs:

- 1 HD-SDI, SDI (SMPTE 259/292/296/424), 1x BNC

#### Video Outputs:

- 3G/HD/SD-SDI input, 6x BNC Equalizing and re-clocking

#### Return Loss:

- >15db to 3Gb

#### Power:

- +5-18VDC Regulated, 4 Watts, Requires Power Supply

#### Size:

- 5.8" x 3.1" x 1" (131 x 79 x 25mm)

## GEN10 HD/SD Sync Generator



The GEN10 is a cost effective and flexible SD/HD/AES sync generator. The GEN10 features 7 outputs including 2 groups of independently controlled SD/HD sync outputs and 1 AES-11 output. The SD outputs can be switched between Color Black or Color Bars. HD tri-level sync can be switched between 19 different HD formats including all that are in use today. The AES-11 output can be switched between SILENCE and TONE. All outputs are in sync with each-other and are sourced from an accurate master time base.

### Features

- HD Tri-level sync generation
- SD Color Black or Color Bars
- Two groups of independently switchable outputs allows simultaneous HD and SD sync generation
- AES-11 output switchable between silence and tone
- Multiple outputs can synchronize entire systems without requiring a Sync DA
- 5-18VDC Power
- External Dip Switch Configuration
- 5 Year Warranty

### Specifications

#### HD Sync:

- Trilevel

#### SD Sync:

- Color Black - 75% Color Bars

#### AES:

- AES-11, 48KHz, Silent or 1KHz Tone (-20dBFS for NTSC, -18dBFS for PAL)

#### Accuracy:

- 3 ppm

#### Formats:

- 525i, 625i
- 720p23.98/24/25/29.97/30/60
- 1080i50/59.94/60
- 1080psF23.98/24/25/29.97/30
- 1080p23.98/24/25/29.97/30

#### User Controls:

- (External Dipswitch)

#### Size:

- 5.8" x 3.1" x 1" (147 x 79 x 25 mm)

#### Power:

- +5-18VDC, 2 watts
- Requires Power Supply

## HD10C2 HD-SDI and SDI Digital to Analog Converter



The HD10C2, AJA's second generation HD D/A converter, brings exciting new features. In addition to being a high-quality 10-bit HD converter, the HD10C2 is "dual-rate" and works with both HD-SDI and SDI inputs. For HD-SDI inputs, the HD10C2 outputs full bandwidth HD component or "VGA" style RGBHV video. For SDI inputs, component or composite SD outputs are supported. When connected to a multi-format monitor like the Sony 20L5, the HD10C2 will automatically provide an image from almost any HD or SD input format. The HD10C2 also features 2 equalized HD-SDI outputs. A 3BNC breakout cable and SVGA adapter are included. Optional 5 BNC cable available for separate H & V for HD only.

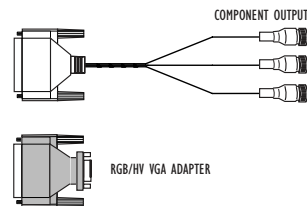

### Features

- High-Quality 10-bit Dual Rate HD/SD D/A Conversion
- Full Bandwidth HD Analog RGB or YPbPr Output (HD input)
- Component/Composite SD Output (SD input)
- 2 Equalized Loop-Thru HD-SDI/SDI Outputs
- RGBHV VGA style HD output using supplied adapter
- HD Sync Selectable Between Bi-level and Tri-Level
- 4:3 Safe Area Graticule (HD)
- 5-18VDC Power
- External Dip Switch Configuration
- 5 Year Warranty

### Specifications

#### Formats:

- HD: 1080i 50/59.94/60 Hz
- 1080psf 23.98/24/25/29.97/30 Hz
- 720p 59.94/60 Hz
- SD: 525 59.94Hz, 625 50Hz
- (Automatic Configuration)

#### Input:

- HD/SD-SDI or SDI SMPTE 259/292/296, 10-bit, BNC

#### Input Equalization:

- Belden 1694 Cable. HD: 100 meters, SD: 100 meters

#### Outputs:

- HD: YPbPr • RGB (SMPTE-274) • SD: YPbPr (SMPTE/N10 • Beta® RGB • Y/C • NTSC/PAL®) • 13W3 wideband analog output connector (cable supplied)

#### Sync:

- HD: Tri-level or Bi-level, H/V Drive
- SD: normal SD sync

#### Frequency Response:

- HD: Y +0, -5db to 30 MHz, C +/- .25db to 13 MHz • SD: Y +/- .25db to 5.5 MHz, C +/- .25db to 2.5 MHz

#### User Controls:

- (External Dipswitch) • YPbPr/RGB
- Component/Composite (SD) • SD Pedestal • SD Blanking • HD 4:3 Graticule
- SD NTSC/NTSC-J • Sync on Video on/off

#### Size:

- 5.8" x 3.1" x 1" (147 x 79 x 25 mm)

#### Power:

- +5-18VDC • 4 watts Requires Power Supply

## HD10MD3 HD/SD-SDI to SDI/Analog Downconverter



The HD10MD3 is a miniature digital downconverter for converting HD-SDI video to broadcast-quality standard definition SDI and analog component/composite video. The HD10MD3 uses a full 10-bit data path and multi-point interpolation to produce excellent quality down-converted video. In addition, the HD10MD3 converts 23.98/24Hz 1080psf/p to 59.94Hz output video using the standard 3:2 pulldown technique. If present, the HD10MD3 will use RP-188 timecode to set the 3:2 pulldown cadence. The output can be formatted for either 4:3 or 16:9 standard definition monitors. For 4:3 monitors both Letterbox and Crop modes are supported. 8 Ch embedded audio is passed to the SDI output. The HD10MD3 is also dual-rate in that SDI inputs will also pass to the SDI and analog outputs.

### Features

- Low-Cost Broadcast-Quality 10-bit HD to SD Downconverter
- Multi-Standard HD-SDI or SDI Input
- 2 Equalized Loop-Thru HD/SD-SDI Outputs
- SDI and Component/Composite Analog Outputs
- 3/2 Pulldown for 23.98/24 Hz p/psf inputs
- Full 10-bit Data Path, Multi-point Interpolation
- Configurable for 16:9 or 4:3 Monitors
- Letterbox and Crop Modes
- 4:3 Safe-Zone Graticule
- Passes 8 Ch embedded Audio, 4 Ch on Downconvert
- 5-18VDC power
- External Dip Switch Configuration
- 5 Year Warranty

### Specifications

#### Formats:

- 1080i 50/59.94/60 Hz
- 1080p/psf 23.98/24/25/29.97/30 Hz
- 720p 50/59.94/60 Hz (Automatic Configuration)

#### Inputs:

- HD/SD-SDI SMPTE 259/292/296
- 10-bit - BNC

#### Outputs:

- SDI - SMPTE 259M • 10-bit - BNC
- YPbPr - SMPTE - EBU-N10 • Betacam
- RGB - NTSC • PAL • YC (S-Video) • 10-bit 3 x BNC

#### Downconversion:

- Multi-point interpolation, 10-bit processing 3:2 conversion for 23.98/24p/psf inputs

#### Frequency Response:

- Y +0, -.5db to 5.5MHz
- C +/- .25db to 2.5MHz

#### User Controls:

- (External Dipswitch) • Output Video Format • 4:3/16:9 Monitor Select
- Letterbox/Crop • Pedestal (Output)
- 4:3 Safe-Zone Graticule Overlay

#### Size:

- 5.8" x 3.1" x 1" (147 x 79 x 25 mm)

#### Power:

- 5-18VDC, 5 watts • Requires Power Supply

## HD10A HD Analog to HD-SDI Converter



The HD10A is a miniature, high-quality, 10-bit analog to digital converter for HDTV. A companion to the popular HD10C2 D/A converter, the HD10A can add an HD-SDI output to cameras, computers with HD RGB, VTRs, or other analog-only high definition equipment. The HD10A accepts RGB or YPbPr analog HD and outputs three duplicate HD-SDI signals. Works in 1080/1035i and 720p with internal or external sync (tri-level).

### Features

- High-Quality 10-bit HDTV A/D Conversion
- Full Bandwidth Component HD RGB or YPbPr Input
- 3 HD-SDI Outputs
- Multi-Standard
- Internal or External Sync
- External Dip Switch Configuration
- Optional 12V Power (requires upgrade)
- 5 Year Warranty

### Specifications

#### Formats:

- 1080i 50/59.94/60 Hz
- 1080psf 23.98/24
- 1035i 50/59.94/60 Hz
- 720p 23.98/24/29.97/30/59.94/60 Hz

#### Inputs:

- YPbPr, RGB (SMPTE-274)
- 3 x BNC External Sync, 1 x BNC

#### Outputs:

- HD-SDI, SMPTE-292/296 3 x BNC

#### Frequency Response:

- Y +0, -.5db to 30 MHz
- C +/- .25db to 15 MHz

#### User Controls:

- (External Dipswitch) • RGB/YPbPr input
- 1.00/1.001 clock • Internal/External Sync

#### Size:

- 5.8" x 3.1" x 1" (147 x 79 x 25 mm)

#### Power:

- +5 VDC, 4 watts • Requires Power Supply

## HD10CEA HD/SD-SDI to Analog Audio/Video

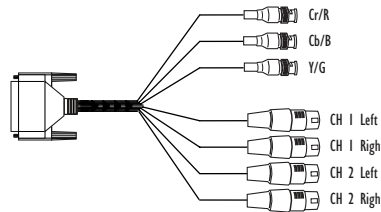

The HD10CEA converts HD/SD-SDI video with embedded audio to analog video and 4 channel balanced analog audio. SD video outputs can be configured as YPbPr (Betacam or SMPTE/EBU-N10), RGB, composite or YC (S-Video). HD video outputs can be configured as YPbPr or RGB. The analog audio outputs can be wired in a balanced or unbalanced configuration. The 4 audio channels can be selected from group 1-4. Audio and video output connections are available on a 25 pin "D" subminiature connector (3x BNC 4x XLR breakout cable supplied). All video/audio configuration is done by external dipswitch selection. This versatile, low-cost, miniature monitoring solution also outputs two loop-thru HD/SD-SDI outputs. **Note:** The HD10CEA does not up or down convert between HD and SD.

### Features

- Digital to Analog Audio and Video Converter
- HD/SD-SDI with Embedded Audio Input
- SD Component or Composite Video Outputs (SD Input)
- HD Component Video Outputs (HD Input)
- 4 Channel Balanced Audio Output
- 2 Equalized, Loop-Thru SD/HD-SDI Outputs
- Selectable Audio Channel Pair/Group
- 5 Year Warranty

### Specifications

- Inputs:**
- HD/SD-SDI w/Embedded Audio
  - 1x BNC
- Outputs:**
- SD Video: YPbPr - SMPTE - EBU-N10
- Betacam • RGB • NTSC - PAL • YC (S-Video) • **HD Video:** YPbPr • **RGB**
- Audio:** 4 Channel Balanced/Unbalanced
- Video/Audio Outputs on 25 Pin D Connector • 2 SDI/HD-SDI Equalized Loop-Thru • 2x BNC
- User Controls:**
- External Dipswitch • Video Format
  - Pedestal • H/V Blanking • Audio Group 1 - 4 • Audio Level (adjustable via switch selection): +24, +18, +15, +12 dBu • Full Scale Digital
- Size:**
- 5.8" x 3.1" x 1" (147 x 79 x 25mm)
- Power:**
- +5-18VDC, 4 watts • Requires Power Supply

## HD10AVA HD/SD Analog Composite or Component Video and 4 Ch Analog Audio to SD/HD-SDI w/Embedded Audio

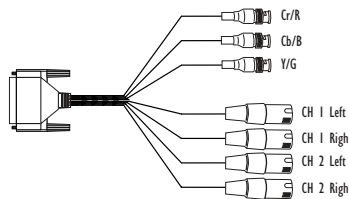

The HD10AVA is a miniature, high-quality, audio/video, HD/SD A/D converter. The HD10AVA automatically detects the video input format and embeds the audio inputs in the HD/SD-SDI outputs. The HD10AVA is useful for adding an HD/SD-SDI audio/video output to tape decks or any professional video equipment with analog outputs. The HD10AVA is especially useful for adding HD-SDI outputs to most HDV cameras or decks by using the component outputs of such devices. The HD10AVA uses a 3x BNC, 4x XLR breakout cable (included) for audio/video inputs and provides 3 HD/SD-SDI on BNCs. **Note:** The HD10AVA does not up or down convert between HD and SD.

### Features

- High-Quality HD/SD Audio/Video A/D Converter
- SD Component, Composite or Y/C Video Input
- HD Analog Component Video Input
- Four Channel Balanced Analog Audio Input
- 3 SDI/HD-SDI w/embedded Audio Outputs
- 12 Bit Video, 24 Bit Audio A/Ds
- Automatic Multi-Standard
- External Dip Switch Configuration
- 5-18V Power
- 5 Year Warranty

### Specifications

- Formats:**
- 525i/625i, 1080i 50/59.94/60 Hz
  - 1080psf 23.98/24/25 Hz
  - 1035i 50/59.94/60 Hz
  - 720p 50/59.94/60 Hz
- Video Inputs:**
- HD component YPbPr, (SMPTE-274), BNC • SD component/composite/YC (S Video), BNC
- Audio Inputs:**
- 4 Channel Balanced, XLR
- Outputs:**
- SDI, HD-SDI, SMPTE-259/292/296
  - 3 x BNC
- Video A/D:**
- 12 bits
- Audio A/D's:**
- 24 Bits, 48KHz
- Audio levels:**
- +24, +18, +15, +12 dBu • Full Scale Digital
- User Controls:**
- (External Dipswitch) • Component/Composite (SD) • Composite/YC (SD) • Pedestal Present (on/off) (SD) • Audio Input Level • Embed Audio on/off
- Size:**
- 5.8" x 3.1" x 1" (147 x 79 x 25 mm)
- Power:**
- +5-18VDC, 5 watts • Requires Power Supply

## HD10DA 1x6 HD/SD-SDI Distribution Amplifier



The HD10DA is a miniature, low-cost 1x6 HD/SD-SDI (dual-rate) re-clocking distribution amplifier. Featuring six separately buffered HD/SD-SDI outputs, the HD10DA provides automatic input HD cable EQ to 125 meters.

### Features

- Compact HD/SD-SDI Distribution
- Six Separately Buffered Outputs
- Miniature Size
- Cable equalization (1694 coax). HD 125m, SD 300m
- HD-SDI or SDI input, auto sensing
- Bi-color LED indication of input lock and rate
- Passes all ancillary data
- +5-18VDC
- No dip switches or configuration required
- 5 Year Warranty

### Specifications

- Formats:**
- 1.5Gb, 143, 177, 270, 360 Mb
  - Auto Select
- Inputs:**
- 1 HD/SD-SDI • SDI (SMPTE 259/292/296)
  - 1x BNC
- Outputs:**
- HD/SD-SDI • 6x BNC Equalizing and re-clocking
- Power:**
- 5 to 18VDC Regulated • 2.5 Watts
  - Requires Power Supply
- Size:**
- 5.8" x 3.1" x 1" (147 x 79 x 25 mm)

## HD5DA 1x4 HD/SD-SDI Distribution Amplifier/Repeater



The HD5DA is a miniature, low-cost 1x4 HD/SD-SDI distribution amplifier/repeater. Featuring four separately buffered HD/SD-SDI outputs, the HD5DA provides automatic HD cable equalization to 125 meters and automatically adapts to 143, 177, 270, 360 Mb, and 1.5Gb SDI.

### Features

- Compact HD-SDI/SDI Distribution
- Four Separately Buffered HD-SDI/SDI Outputs
- Auto Equalization
- Beldco 1694 cable. HD 125m, SD 300m
- Acts As Low-Cost Repeater
- Automatic Multi-Standard 143/177/270 Mb, 1.5Gb
- Miniature Size
- 5 Year Warranty

### Specifications

- Formats:**
- 1.5Gb, 143, 177, 270, 360 Mb
  - auto select
- Inputs:**
- 1 HD-SDI, SDI (SMPTE 259/292/296)
  - 1 x BNC
- Outputs:**
- 4 HD-SDI • SDI • 4 x BNC Equalizing
- Size:**
- 5.1" x 2.4" x 1" (131 x 61 x 25 mm)
- Power:**
- +5VDC Regulated • 2.5 Watts
  - Requires Power Supply



## HD10AMA HD/SD-SDI 4 Channel Analog Audio Embedder/Disembedder

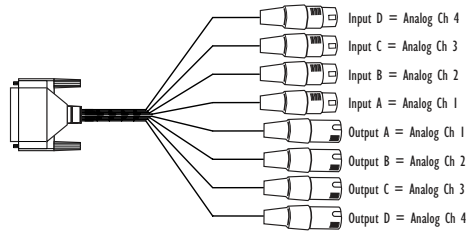

The HD10AMA is a dual rate 4 channel analog audio Embedder/Disembedder. The Disembedder is always functional providing 4 outputs. The Embedder is user selectable, on a channel pair basis, to either "pass" input audio or embed input audio from the breakout cable. Analog audio levels are selectable. The HD10AMA automatically detects and configures to the input video standard. 8 x XLR breakout cable included.

### Features

- Dual rate HD/SD-SDI Embedder/Disembedder
- 4 Channel Balanced Analog Audio I/O
- Supplied XLR breakout cable
- HD-SDI/SDI input, 2 HD-SDI/SDI outputs
- Dipswitch configuration
- 5-18VDC Power
- 5 Year Warranty

### Specifications

- Formats:**
- HD SMPTE 292/296M • SD SMPTE 259M • (Automatic Configuration)
- Video Input:**
- HD/SD-SDI BNC
- Video Outputs:**
- Follows input, 2 x BNC
- Audio Inputs:**
- 4 x Balanced Analog Audio • XLR
  - Outputs: 4 x Balanced Analog Audio
  - XLR • Audio Levels (Full Scale Digital): +24dBu, +18dBu, +12dBu, +6dBu
  - Audio Converters: 24 bit
- Embedded Audio:**
- SMPTE 272M/299M, 24 bit, 48KHz synchronous
- User Controls:**
- (External Dipswitch) • Embedder on/off
  - Ch pairs 1/2 - 3/4 • Input group select 1-4 • Output Group Select 1-4 • Audio Level: Pro/Consumer
- Size:**
- 5.8" x 3.1" x 1" (147 x 79 x 25 mm)
- Power:**
- +5-18VDC • 5 watts • Requires Power Supply

## HD10AM HD/SD-SDI 8 Channel AES Embedder/Disembedder

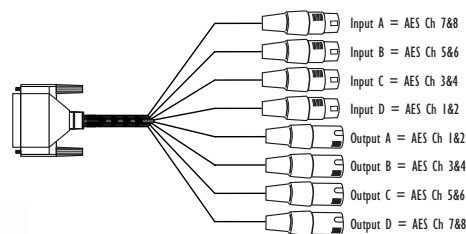

The HD10AM is a dual rate 8 channel AES audio Embedder/Disembedder. The Disembedder is always functional providing 4 AES outputs. The Embedder is user selectable, on a channel pair basis, to either "pass" SDI input audio or embed input AES audio from the breakout cable. AES inputs are sample rate converted to a 48KHz rate synchronous to the video input. The HD10AM automatically detects and configures to the input video standard. 8 x XLR breakout cable included.

### Features

- Dual rate HD/SD-SDI Embedder/Disembedder
- 8 Channel AES I/O
- Supplied breakout cable for balanced AES - XLR connectors
- HD-SDI/SDI input, 2 HD-SDI/SDI outputs
- Dipswitch configuration
- 5-18VDC Power
- 5 Year Warranty

### Specifications

- Formats:**
- HD SMPTE 292/296M • SD SMPTE 259M • (Automatic Configuration)
- Video Inputs:**
- HD/SD-SDI BNC
- Video Outputs:**
- follows input, 2 x HD/SD-SDI BNC
- Audio Inputs:**
- 4 x AES 110 ohm XLR
- Audio Outputs:**
- 4 x AES 110 ohm XLR
- AES audio:**
- SMPTE 272M/299M, 24 bit, 48KHz synchronous
- User Controls:**
- (External Dipswitch) • Embedder on/off
  - Ch pairs 1/2 - 7/8 • Input group select, 1/2, 3/4 • Output Group Select, 1/2, 3/4 • SRC Bypass
- Size:**
- 5.8" x 3.1" x 1" (147 x 79 x 25 mm)
- Power:**
- +5-18VDC, 5 watts • Requires Power Supply

## ADA4 4-Channel Bi-directional Audio A/D and D/A Converter

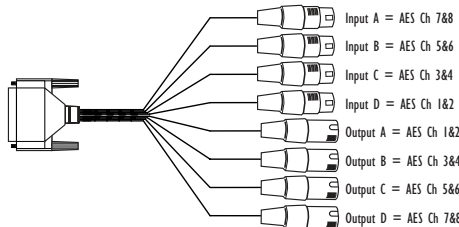

The ADA4 is a 4 channel bi-directional converter which can be configured as a 4 channel A/D, a 4 channel D/A, 2 channel A/D and 2 channel D/A, or an AES synchronizer. The ADA4 can accept a AES11, wordclock, or video sync/color black reference input for synchronization. Reference input and synchronization is automatic. Audio levels are configurable via dipswitch control.

### Features

- 4 Simultaneous A/D and D/A, or AES Synchronizer
- Full-time AES11 low jitter reference output
- Up to 4 channels of balanced analog to AES/EBU audio
- Up to 4 channels of AES/EBU to balanced analog audio
- Supplied XLR breakout cable AES11/Wordclock/Tri-level Sync/
- Color Black Reference Loop
- Adjustable Audio Levels
- Sample Rate Conversion Between 96KHz and 48KHz Dipswitch configuration
- 5-18VDC Power
- 5 Year Warranty

### Specifications

- Analog Audio I/O:**
- Balanced, XLR, one channel per XLR connector
- AES Audio I/O:**
- Balanced 110 ohm, XLR, two channels per XLR connector
- Analog Audio Levels:**
- +24dBu (SMPTE RP155) - +18dBu (EBU R68)
  - +15dBu - +12dBu (consumer +10dBV)
- Audio Converters:**
- 24 bit, 48/96 KHz
- User Controls:**
- (External Dipswitch) • Channel 1/2: A/D, D/A • Channel 3/4: A/D, D/A • Audio Level 1 • Audio Level 2
- Reference Loop:**
- 75 Ohm (unterminated), HD/SD Sync, AES-11, or Wordclock (48/96 KHz)
- Size:**
- 5.8" x 3.1" x 1" (147 x 79 x 25 mm)
- Power:**
- +5-18VDC, 3 watts • Requires Power Supply



## HDP2 HD-SDI/SDI to DVI-D and Audio Converter

The HDP2 is a miniature HD-SDI/SDI to DVI-D converter for digital display devices, such as LCD, DLP, and Plasma monitors or projectors. Using a very high quality scaling engine and de-interlacer, the HDP2 will automatically size 4:3 or 16:9 inputs to many DVI-D monitors. For appropriate monitor configurations, scaling is automatically 1 to 1—for example, displaying 1920x1080 video on a WUXGA (1920x1200) monitor. The HDP2 will also automatically adapt the input frame rate for monitor compatibility. In addition, the HDP2 provides 2 channel audio monitoring and a looping output of the SDI input.

The HDP2 is designed for general monitoring, perfect for use in applications such as: General post-production reference monitoring, Client monitoring, Presentation, Projection, Corporate displays, Kiosk applications ...and much more

The HDP2 also supports HDMI v1.3a Deep Color (with a DVI to HDMI cable). In the HDMI mode, Deep Color is supported at 30 bits per pixel with 8 channel audio. USB connectivity allows for easy PC/Mac setup and field upgrades.

### Features

- HD-SDI/SDI to DVI-D
- HDMI 1.3a support (via DVI-D connector), including:
  - Deep Color 30-bit video (24-bit also supported)
  - 2 or 8 channels of embedded audio
- Automatically adapts to popular LCD/DLP/Plasma monitors (and projectors) up to 1920x1200 and 1080p
- High quality scaling engine for proper display of 4:3 or 16:9 content—even better quality than original HDP
- 1 to 1 scaling for appropriate monitor configurations
- 2 channel RCA analog audio output (user-assignable channels)
- HD-SDI/SDI looping output
- Setup via PC/Mac using USB port and supplied USB cable (USB configuration software application supplied on CD)
- 5 year warranty

### Specifications

- Inputs:**
- 525i, 625i, 720p 50/59.94/60, 1080i 50/59.94/60, 1080p 23.98/24/25/29.9/30 1080psF 23.98/24/25, YCbCr 10-bit
- Video Inputs:**
- HD, and SD-SDI (auto-selected), SMPTE-259/274/292/296, BNC connector
- Video Outputs:**
- DVI v1.0 / HDMI v1.3a, 4:2:2 YCbCr, 4:4:4 YCbCr/RGB 24/30-bit, DVI-D standard male connector
- Audio Outputs:**
- RCA-style analog outputs at -10dBV (nominal), 2 channels embedded audio (HDMI mode only), 24 bit, 2 or 8 channels, User assignable channels
- Power:**
- +5-18 VDC regulated, 5 watts
- Size:**
- 5.8" x 3.1" x 1 (147mm x 79mm x 25mm)

## HA5 HDMI to HD/SD-SDI Video and Audio Converter



The HA5 converts HDMI to SDI or HD-SDI. Two channels of HDMI audio are embedded into the HD/SD-SDI output allowing a convenient single cable audio/video connection. The HA5 provides two SDI/HD-SDI outputs and supports long HDMI cables on the input. The HA5 is useful for connecting HDMI cameras to HD/SD-SDI equipment.

### Features

- HDMI to HD/SD-SDI
- Full HDMI support including embedded audio
- Equalized HDMI input supports long HDMI cables up to 30m, 24 gauge
- PLL clock filtering for low jitter HD/SD-SDI outputs
- Lock LED shows type of input source, SD (green) or HD (red)
- HDMI V1.2 standard
- 1m HDMI cable included
- 5 year warranty

### Specifications

#### Input:

- HDMI with embedded audio

#### Input Formats:

- 525i • 625i • 720p 50/59.94/60 • 1080i 50/59.94/60 • 1080p23.98 • 1080p24, 1080p25 • 1080p29.97 • 1080p30

#### Outputs:

- SMPTE-259/292/296 SDI/HD-SDI
- 2 x BNC

#### Power:

- +5VDC Regulated • 4 watts
- Requires Power Supply

#### Size:

- 4.6" x 2.4" x 1" (117 x 61 x 25mm)

Note: HDCP content not supported

## Hi5 HD/SD-SDI to HDMI Video and Audio Converter



The Hi5 converts HD/SD-SDI to HDMI for driving HDMI monitors. Embedded 8-channel HD/SD-SDI audio is supported in the HDMI output allowing a convenient single cable audio/video connection. The Hi5 provides 2 Channel RCA style audio outputs for separate audio monitoring if needed. The Hi5 also provides a looping HD/SD-SDI output useful for connecting additional equipment, or for "daisy chaining" multiple monitors to the same HD/SD-SDI source.

### Features

- HD/SD-SDI to HDMI
- Full HDMI support including embedded audio
- Additional 2 Channel RCA jack audio output
- Equalized looping HD/SD-SDI output
- No configuration necessary
- HDMI V1.2 standard
- 1m HDMI cable included
- 5 year warranty

### Specifications

#### Inputs:

- SMPTE-259/292/296 HD/SD-SDI

#### Input Formats:

- 525i • 625i • 720p 50/59.94/60 • 1080i 50/59.94/60 • 1080p23.98 • 1080p24 • 1080p25 • 1080p29.97 • 1080p30

#### Outputs:

- HDMI with embedded audio
- Audio (2 channel RCA-style outputs)
- 1 equalized looping SDI/HD-SDI output

#### Power:

- +5VDC, 3 watts, Requires Power Supply

#### Size:

- 4.6" x 2.4" x 1" (117 x 61 x 25mm)

Note: HDCP content not supported.

## Hi5-3G 3G/Dual-link/HD/SD-SDI To HDMI 1.3a Video and Audio Converter



The Hi5-3G converts 3G-SDI, dual or single link HD-SDI, or SD-SDI to HDMI v1.3a for driving HDMI monitors. HDMI v1.3a capability at 30 bits per pixel allows full support of the latest 10 bit monitors. Audio is supported in the HDMI output allowing a convenient single cable audio/video connection. The Hi5-3G provides 2 Channel RCA style audio outputs for separate audio monitoring if needed. USB connectivity allows for easy PC/Mac setup and field upgrades.

### Features

- 3G/HD/SD-SDI to HDMI
- SMPTE425M-AB input
- Full HDMI 1.3a support including:
  - Deep Color 30- and 36-bit video per pixel (24-bit also supported)
  - 2 or 8 channels of embedded audio
- Additional 2 channel RCA analog audio output (User assignable channels)
- Setup via PC/Mac using USB port and supplied USB cable (USB configuration software application supplied on CD)
- 1m HDMI cable supplied
- Uses 5V power (supply sold separately)
- 5 year warranty

### Specifications

#### Input Formats:

- 525i, 625i, 720p 50/59.94/60, 1080i 50/59.94/60, 1080p 23.98/24/25/29.9/30/50/59.94/60 1080psF 23.98/24/25/29.97/30 YCbCr/RGB/XYZ 10/12-bit

#### Video Inputs:

- 3G, HD, and SD-SDI (auto-selected), SMPTE-259/274/292/296/372/424/425, 2x BNC

#### Video output:

- HDMI v1.3a, 30/36 bits per pixel, RGB or YUV, 2.25Gbs, SD, HD, 1080p50/60, HDMI Standard Type A connector

#### Audio Outputs:

- HDMI embedded audio, 24 bit, 2 or 8 channels RCA-style analog outputs at -10dBV (nominal), User assignable channels

#### Size:

- 5.8" x 3.1" x 1" (147mm x 79mm x 25mm)

#### Power:

- +5 VDC regulated, 5 watts (AJA power supply model DWP or DWP-U recommended)

#### NOTE:

The Hi5-3G does not encode the HDMI output with HDCP encryption. By definition, SDI/HD-SDI inputs to the Hi5-3G are unencrypted.

## D10CE SD-SDI to Component and Composite Analog Converter, 10-bit



The D10CE SDI to Analog Video Converter provides excellent-quality 10-bit conversion of SD-SDI to both component and composite video formats simultaneously. The component outputs are user configurable to YPbPr (SMPTE, EBU-N10), Betacam, or RGB (or composite and Y/C). The composite output is configurable to composite video or sync. The component and composite outputs are completely independent including optimum chroma filtering for each and independent pedestal configuration. The D10CE also features an exclusive PLL jitter filter/memory to reduce the effects of SDI jitter on the output analog video. This feature, along with the precision 4x oversampled D/A filters, provides the highest quality analog outputs - including very low phase noise in composite outputs. The D10CE also provides two re-clocked, loop-thru SDI outputs. All functions are user configurable via dip switches.

### Features

- Excellent-Quality 10-bit Universal D/A Conversion
- Full 10-bit Data path, 4x Oversampling
- SD-SDI Input, 2 Re-clocked, Loop-Thru SDI Outputs
- Simultaneous Component and Composite Analog Outputs
- YPbPr, Betacam, or RGB Component Formats
- NTSC or PAL Composite Formats
- Precision PLL Jitter Filter for Stable Composite Outputs
- Digital Noise Reduction
- External Dip Switch Configuration
- 5 Year Warranty

### Specifications

#### Input:

- SD-SDI (SMPTE 259M) - 1 x BNC

#### Outputs:

- (Simultaneous Component and Composite output) • YPbPr - SMPTE, EBU-N10, Betacam • RGB • NTSC • PAL
- YC (S-Video) 3 x BNC • NTSC/PAL or Sync • 1 x BNC • Re-clocked loop-thru SD • 2 x BNC

#### D/A Converters:

- 10-bits, 4x oversampling • Clock Jitter Filtering to 2.5Hz

#### Frequency Response:

- Y +/- .15dB to 5.5MHz • C +/- .15dB to 2.5MHz (Component) • C +/- .15dB to 1.3MHz (Composite) • Less than .5% K Factor (2T)

#### User Controls:

- (External Dip Switch ) • Output Video Format • Pedestal On/Off • Narrow/ Wide Blanking • Digital Noise Reduction

#### Power:

- +5VDC Regulated, 4 Watts • Requires Power Supply

#### Size:

- 5.8" x 3.1" x 1" (147 x 79 x 25 mm)

## D10C2 SD-SDI to Component or Composite Analog Converter, 10-bit



The D10C2 SD-SDI to Analog Video Converter provides excellent-quality 10-bit conversion of SD-SDI to analog component or composite video at low cost. In the Component mode the D10C2 outputs are user configurable to YPbPr (SMPTE, EBU-N10), Betacam, or RGB. In the Composite mode, the D10C2 provides 2 composite outputs and a Y/C (S-Video) output. The D10C2 also provides two re-clocked, loop-thru SDI outputs and a composite sync output (Component mode). All functions are user configurable via dip switches.

### Features

- Excellent-Quality 10-bit Universal D/A Conversion
- Full 10-bit Data path, 4x Oversampling
- SD-SDI Input, 2 Re-clocked, Loop-Thru SDI Outputs
- Component or Composite Analog Output
- YPbPr, Betacam, or RGB Component Formats
- NTSC or PAL Composite Formats
- Digital Noise Reduction
- External Dip Switch Configuration
- 5 Year Warranty

### Specifications

- Input:**
- SD-SDI (SMPTE 259M) • 1 x BNC
- Outputs:**
- Component Mode: YPbPr - SMPTE • EBU-N10, Betacam • RGB, 3 x BNC
  - Sync • 1 x BNC
  - Composite Mode: NTSC/PAL 2 x BNC
  - YC (S-Video) 2 x BNC • Re-clocked loop-thru SDI, 2 x BNC
- D/A Converters:**
- 10-bits, 4x oversampling
- Frequency Response:**
- Y +/- .15dB to 5.5MHz • C +/- .15dB to 2.5MHz (Component) • C +/- .15dB to 1.3MHz (Composite) • Less than .5% K Factor (2T)
- User Controls:**
- (External Dip Switch) • Output Video Format • Pedestal On/Off • Narrow/Wide Blanking • Digital Noise Reduction
- Power:**
- +5VDC Regulated • 4 Watts • Requires Power Supply
- Size:**
- 5.8" x 3.1" x 1" (147 x 79 x 25 mm)

## D10CEA SD-SDI to Analog Audio and Video Converter, 10-bit

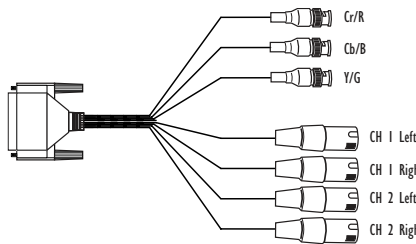

The D10CEA converts SD-SDI video with embedded audio to 10-bit component or composite analog video and 4 channel balanced analog audio. The video outputs can be configured as YPbPr (Betacam or SMPTE/EBU N10), RGB, 1 composite or 1 Y/C (S-Video). The 4 ch analog audio outputs can be wired in a balanced or unbalanced configuration. The 4 audio output channels can be selected as group 1-4 from SMPTE embedded audio. Audio level has 4 settings. Audio and video output connections are available on a 25 pin "D" subminiature connector – a break-out cable is supplied. All video/audio configuration is done by external dipswitch selection. This versatile, low-cost, miniature monitoring solution also outputs two re-clocked loop-thru SDI outputs.

### Features

- SD-SDI to Analog Audio and Video Converter
- SDI with Embedded Audio Input
- 2 Re-clocked, Loop-Thru SDI Outputs
- 10-bit Component or Composite Analog Video Outputs
- 4 ch Balanced Analog Audio Output
- Selectable Audio level
- Selectable Audio Channel Group
- External Dip Switch Configuration
- 5 Year Warranty

### Specifications

- Inputs:**
- SD-SDI (SMPTE 259M) w/embedded audio • 1 x BNC
- Outputs:**
- Video: YPbPr - SMPTE • Betacam
- RGB • NTSC • PAL • YC (S-Video) • 10-bits
- Audio: 4 Channel Balanced/Unbalanced
- Video/Audio outputs on 25-pin D connector 2 SDI Re-clocked loop-thru • 2 x BNC
- Frequency Response:**
- Video, +/- .25db to 5.5 Mhz Y
  - Audio, +/- .5db to 20Khz
- User Controls:**
- (External Dip Switch) • Video format Pedestal • H&V blanking • Audio group 1,2,3,4 • Audio Level, adjustable via switch selection: +24, +18, +15, +12 dBu • Full Scale Digital
- Size:**
- 5.8" x 3.1" x 1" (147 x 79 x 25 mm)
- Power:**
- +5VDC Regulated, 4 watts • Requires Power Supply

## D10C Composite Serial Digital (D2, D3) to Composite Analog, or SD-SDI to YPbPr or RGB Converter, 10-bit



The D10C SDI to Analog Converter provides excellent quality 10-bit digital to analog conversion at low cost. The D10C is useful for D/A conversion, high-quality monitoring, or adding an SDI input to VTRs, workstations, or other analog video equipment. The D10C automatically works with component or composite SDI inputs in 625 or 525 line formats. Featuring one SDI input with two re-clocked, loop-thru SDI outputs, the D10C also acts as a distribution amplifier/repeater. The D10C provides a component analog output for component SDI inputs (D1), a NTSC output for 525 line composite SDI inputs (D2, D3), and a PAL output for 625 line composite inputs SDI (D2, D3). Note: the D10C is set to the proper format at the factory.

### Features

- Excellent Quality 10-bit D/A Conversion
- SD-SDI Input, 2 Re-clocked, Loop-Thru SDI Outputs
- Accepts Component or Composite SDI Inputs (D1, D2, D3)
- YPbPr, Betacam, or RGB Component Formats
- NTSC or PAL Composite Formats (with D2/3 input)
- 5 Year Warranty

### Specifications

- Input:**
- SD-SDI (SMPTE 259M), 1 x BNC
- Outputs:**
- For Component Input Only (270Mb): YPbPr - SMPTE • EBU-N10 • Betacam
  - RGB, 3 x BNC • Sync • 1 x BNC • For Composite Input Only (143/177Mb): NTSC/PAL 1 x BNC • Re-clocked loop-thru SDI • 2 x BNC
- D/A Converters:**
- 10-bits
- Frequency Response:**
- Y +/- .25dB to 5.2MHz • C +/- .25dB to 2.5MHz • Less than 1% K Factor (2T)
- Power:**
- +5VDC Regulated • 5 Watts • Requires Power Supply
- Size:**
- 5.8" x 3.1" x 1" (147 x 79 x 25 mm)

## D10AD Component or Composite Analog to SD-SDI Converter, 10-bit



The D10AD provides excellent-quality 10-bit conversion of component or composite analog video to SDI with EDH. The D10AD accepts YPbPr (SMPTE, EBU-N10), Betacam, or RGB component inputs or NTSC/PAL or Y/C (S-Video) composite inputs. The D10AD features a 4 Line Adaptive Comb Filter for high-quality decoding of composite sources. The comb filter can be switched to 2 line or notch modes for minimum delay requirements. NTSC/PAL configuration is automatic. Video format, AGC, and pedestal are all user configurable via dip switches.

### Features

- Excellent-Quality 10-bit Universal A/D Conversion
- Component, Composite or Y/C Analog Input
- 4 Line Adaptive Comb Filter
- Full 10-bit Data path, 2x Oversampling
- YPbPr, Betacam, or RGB Component Formats
- NTSC or PAL Composite Formats
- AGC Mode
- 4 SDI Outputs with EDH
- Color Bar Generator
- 5 Year Warranty

### Specifications

- Inputs:**
- YPbPr - SMPTE • EBU-N10 • Betacam
  - RGB • NTSC • PAL • Y/C (S-Video) 3 x BNC
- Outputs:**
- SDI (SMPTE 259M) w/EDH 4 x BNC
- A/D Converters:**
- 10-bits • 2x oversampling
- Frequency Response:**
- Y +/- .15dB to 5.5MHz • C +/- .15dB to 2.5MHz • Less than .5% K Factor (2T)
- User Controls:**
- (External Dip Switch) • Input Video Format • Pedestal Present/Not Present • AGC On/Off • EDH On/Off • Test Pattern
- Power:**
- +5VDC Regulated • 4 Watts • Requires Power Supply
- Size:**
- 5.8" x 3.1" x 1" (147 x 79 x 25 mm)

## D10A Component to SD-SDI Converter (with Separate Sync Input)



The D10A provides exceptional quality component-only analog to 10-bit SD-SDI. The superior quality of this 10-bit A/D converter has made it a favorite of the professional video engineer. The D10A is pre-set at the factory to accept either YPbPr (SMPTE, EBU/N10), Betacam, or RGB in 525 or 625 line formats, converting the analog component signal to 10-bit SDI. The D10A has three BNC's for one component input, one external sync input, and three SDI outputs. Input formats can be reset by internal jumpers and level/gain controls.

**Features**

- Excellent-Quality 10-bit A/D Conversion
- Component Analog to SDI
- Full 10-bit signal path
- 3 serial outputs
- Multi-Format
- Normal/Wide V-blanking
- 2 loop-through serial outputs
- 5 Year Warranty

**Specifications**

**Inputs:**

- YPbPr (SMPTE • EBU/N10) • Betacam • or RGB • 3 x BNC • External Sync, 1 x BNC

**Outputs:**

- 3 SDI, 3 x BNC

**A/D Converters:**

- 10-bits

**Frequency Response:**

- Y +/- .25dB to 5.5MHz • C +/- .25dB to 2.5 MHz

**Power:**

- +5VDC Regulated • 3 watts • Requires Power Supply

**Size:**

- 5.8" x 3.1" x 1" (147 x 79 x 25 mm)

## D5D Composite and S-Video Analog to SD-SDI Converter



The D5D Decoder provides low-cost, all digital decoding of analog NTSC/PAL or Y/C (S-Video) to SDI. The D5D is useful for bringing video from time-base corrected analog composite equipment into a serial digital environment. The D5D features a crystal PLL jitter filter/memory to reduce jitter in the SDI outputs. The D5D decodes the full dynamic range of input video - values below black and above white are not clipped. In the NTSC mode, the removal of the 7.5 IRE pedestal can be enabled by external dip switch selection.

**Features**

- Analog Composite-Y/C to SDI Conversion
- Selectable 2 or 3 Line Adaptive Comb Filter
- Three SD-SDI Outputs
- Crystal PLL Jitter Filter
- Automatically Configures to NTSC/PAL
- Selectable Pedestal
- External Dip Switch Configuration
- 5 Year Warranty

**Specifications**

**Inputs:**

- NTSC/PAL • Y/C (S-Video) • 2 x BNC

**Outputs:**

- SD-SDI (SMPTE 259M) • 3 x BNC

**Frequency Response:**

- +/- 0.25dB to 5MHz • <1% 2t K Factor (Y)
- < 1.5% Differential Gain • < 1.5 Degree Differential Phase

**User Controls:**

- (External Dip switch) • Composite/YC
- Pedestal in NTSC Mode • Narrow/Wide Blanking • 2 or 3 Line Comb

**Power:**

- +5VDC regulated • 5 Watts
- Requires Power Supply

**Size:**

- 5.1" x 2.4" x 1" (131 x 61 x 25 mm)

## D5CE SD-SDI to Component or Composite Analog Converter



The D5CE provides low cost, all digital conversion of SDI to either composite or component analog video. Three analog BNC outputs are user configurable to cover a wide range of format combinations including 3 composite, 1 composite and Y/C, YPbPr (SMPTE, EBU-N10), Betacam, or RGB. The D5CE also features a re-clocked, loop-thru SDI output. The D5CE automatically adapts to NTSC or PAL video standards. Pedestal and narrow/wide H/V blanking are user configurable via dipswitches.

### Features

- Low Cost SD-SDI to Component or Composite Analog
- User Selectable Component or Composite/YC Outputs
- YPbPr, Betacam, or RGB Component Formats
- Re-clocked Loop-Thru SDI Output
- Automatic NTSC/PAL Selection
- User Selectable Vertical/Horizontal Blanking
- External Dip Switch Configuration
- 5 Year Warranty

### Specifications

- Inputs:**
- SD-SDI (SMPTE 259M) • 1 x BNC
- Outputs:**
- YPbPr - SMPTE, EBU-N10 • Betacam
  - RGB • 3 x BNC Or NTSC • PAL • 3 x BNC Or NTSC/PAL and Y/C • 3 x BNC
  - Loop-thru SDI • re-clocking • 1x BNC
- User Controls:**
- (External Dip switch) • Video Format
  - Vertical/Horizontal Blanking • Pedestal
- Size:**
- 5.1" x 2.4" x 1" (131 x 61 x 25 mm)
- Power:**
- +5V DC regulated power • 2 Watts
  - Requires Power Supply

## D4E SD-SDI to Composite Analog Converter



The D4E SD-SDI Encoder provides the lowest cost all-digital conversion of SDI to analog NTSC or PAL. The D4E is useful for monitoring, level and phase checking, dubbing, etc. The D4E automatically adapts to NTSC or PAL video standards and outputs analog NTSC (525 line input) or PAL (625 line input). Pedestal and narrow/wide H/V blanking are user configurable via dipswitches. The D4E encodes the full dynamic range of input video: levels below black and above white are not clipped.

### Features

- Lowest-Cost SD-SDI to NTSC/PAL Available
- 1 SDI Input, 2 Composite-Y/C Analog Outputs
- Automatic NTSC/PAL Selection
- Built-In Test Pattern
- Ultra-Miniature Size Mounts Anywhere
- External Dip Switch Configuration
- 5 Year Warranty

### Specifications

- Inputs:**
- SD-SDI (SMPTE 259M), 1 x BNC
- Outputs:**
- NTSC, PAL, 2 x BNC Or NTSC/PAL Y/C • 2 x BNC
- User Controls:**
- (External Dip switch) • Video Format
  - Vertical/Horizontal Blanking • Pedestal
  - Test Pattern (requires valid SDI input)
- Size:**
- 5.1" x 1.8" x 1" (131 x 44 x 25 mm)
- Power:**
- +5V DC regulated power • 2 Watts
  - Requires Power Supply



## D5DA 1x4 SD-SDI Distribution Amplifier, Multi-format



The D5DA is a multi-format, 1x4, SD-SDI Distribution Amplifier. The D5DA can be used as a low-cost SDI DA or repeater. The SDI input is equalized for up to 300 meters of cable. In addition, the multi-standard feature allows the D5DA to automatically adapt to 143, 177, 270, or 360 Mb SDI inputs automatically.

### Features

- Compact 1x4 Equalizing SDI Distribution Amplifier
- Low Cost
- Automatic Multi-Standard, 143/177/270 Mb
- Cable EQ to 300 Meters
- Useful as a repeater
- 5 Year Warranty

### Specifications

- Formats:**
- 143 • 177 • 270 • 360 Mb • auto select
- Input:**
- 1 SDI (SMPTE 259M) • 1xBNC
- Outputs:**
- 4 SDI (SMPTE 259M) • 4x BNC
  - Equalizing
- Return Loss:**
- >15 dB-270 MHz (Input and Output)
- Size:**
- 5.1" x 2.4" x 1" (131 x 61 x 25 mm)
- Power:**
- +5V DC regulated power • 2 Watt
  - Requires Power Supply.

## D5PSW SD-SDI Protection Switch



The D5PSW accepts 2 SD-SDI inputs, Primary and Secondary, and automatically switches to the Secondary input if the Primary input is not present or is not a valid SDI signal. An SDI input is considered valid if a proper SMPTE 259 stream is present. A LED indicator is Green if both Primary and Secondary are present, flashing green if the Primary is present but the Secondary is not present, and Orange if the Secondary is present but the Primary is not. The D5PSW has 3 SDI outputs.

### Features

- Dual SD-SDI input protection switch
- 3 SDI outputs
- Low Cost
- Cable EQ to 300 Meters
- Useful as a repeater and/or DA
- Multi color LED status
- 5 Year Warranty

### Specifications

- Formats:**
- 143 • 177 • 270 • 360 Mb SMPTE 259
  - auto select
- Inputs:**
- 2 SDI (SMPTE 259M) • 2xBNC
- Outputs:**
- 3 SDI (SMPTE 259M) • 3x BNC
  - Equalizing • Re-Clocking
- Size:**
- 5.1" x 2.4" x 1" (131 x 61 x 25 mm)
- Power:**
- +5V DC regulated power • 4 Watts
  - Requires Power Supply

## Power Supplies for D- and H-Series Converters



### Specifications

- 100-240v, 50/60Hz Universal input
- 5 volt regulated output
- 10 watt capacity
- Circular, latching output connector with gold-plated pins

### DWP

A new more robust design for 2005, the DWP is a miniature high quality power supply for all of AJA's stand-alone products. Custom manufactured for AJA, the DWP is so small it does not cover the adjacent socket in power strips. With a 2x power over-rating and a molded, latching, circular connector with gold-plated pins, the DWP meets the high reliability requirements of the professional video industry.



### Specifications

- 100-240v, 50/60Hz Universal input
- 5 volt regulated output

### DWP-U

The DWP-U is an in-line universal input version which can accept a power cord anywhere in the world.

## RMB and RMB-10 Rack Mounting Brackets for D- and H-series Converters

### RMB

One Bracket with Mounting screws

### RMB-10

Package of Ten Brackets with Mounting Screw

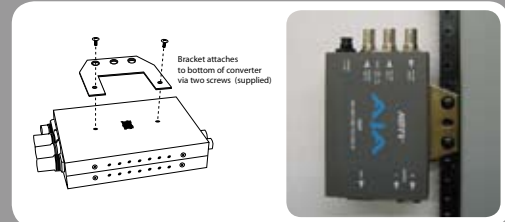

The FR1 and FR2 mounting frames provide high density rack-mount solutions for AJA's R series modules. The FR1 is a 1 RU frame with 4 slots; the FR2 is a 2 RU frame with 10 slots. Both frames feature high capacity power supplies with no power restrictions for any module combination. Also, both frames feature multiple fan forced air cooling which provides ample cooling capacity without the need for empty rack space above or below the units. Both frames feature optional redundant power supplies - the FR2's power supplies are easily changed from the front of the unit. The FR2 features a reference Distribution amplifier which distributes a color black reference to all slots from one input BNC. The FR1 also features a frame reference input with a passive distribution to all 4 slots.

## FR1 One RU Rack Mount Frame & Power Supply, 4 Slot

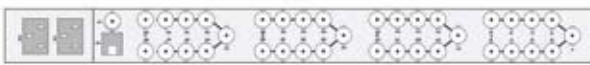

- FR1** FR1 Frame with One FR1-PS Power Supply
- FR1-D** FR1 Frame with Dual FR1-PS (Redundant) Power Supplies Installed
- FR1-PS** Power Supply Module for FR1 Frame

### Features

- 1 Rack Unit Mounting Frame
- 4 Module Capacity
- Multiple Fan Forced Air Cooling
- Optional Redundant Power Supplies
- Power Supply Monitoring
- Frame Reference Input BNC
- UL, CSE, CE Certification
- Universal Input 90-240 VAC 50 Watt Power Supply
- 5 Year Warranty

### Specifications

- Capacity:**
  - 4 Slots • 1 Rack Unit
- Inputs:**
  - Power Supply Monitoring • Reference Input • BNC
- Power:**
  - 40 Watt Capacity • Universal Input 90-240 VAC Power Supply • Optional Redundant Power Supply
  - Diode Isolated
- Cooling:**
  - Multiple Fan Forced Air
- Size:**
  - 19" x 1.75" x 14.75", (1RU)
  - Leitch™ 6800 Series Compatible

## FR2 Two RU Rack Mount Frame & Power Supply, 10 Slot

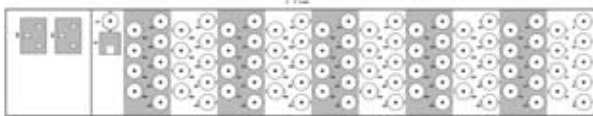

**FR2** FR2 Frame with One FR2-PS Power Supply Installed  
**FR2-D** FR2 Frame with Dual FR2-PS (Redundant) Power Supplies Installed  
**FR2-PS** Power Supply Module for FR2 Frame

### Features

- 2 Rack Unit Mounting Frame
- 10 Module Capacity
- Multiple Fan Forced Air Cooling
- Optional Redundant Power Supplies
- Reference DA sends color black to all slots
- Power Supply Monitoring
- UL, CSE, CE Certification
- Universal Input 90-240 VAC 100 Watt Power Supply
- 5 Year Warranty

### Specifications

- Capacity:**  
10 Slots, 2 Rack Unit
- Inputs:**  
Power Supply Monitoring • Reference Input • BNC – Active DA to all slots
- Power:**  
100 Watt Capacity • Universal Input 90-240 VAC Power Supply • Optional Redundant Power Supply • Diode Isolated
- Cooling:**  
Multiple Fan Forced Air
- Size:**  
19" x 3.5" x 13", (2RU)  
*Leitch™ 6800 Series Compatible*

## RH10UC SD-SDI to HD-SDI Upconverter or HD Frame Synchronizer

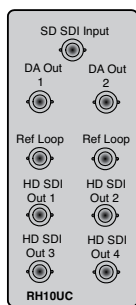

The RH10UC is a 10-bit SD to HD up-converter or HD Frame Synchronizer. Using motion-adaptive de-interlacing and high quality digital scalars, the RH10UC provides excellent Broadcast quality HD video from SD sources. Output HD video is selectable between 720p and 1080i formats. 4:3 to 16:9 aspect ratio conversion is selectable between 4:3 pillarbox, 14:9 crop, 16:9 anamorphic, and 16:9 zoom. Input SD ITU Rec. 601 color space is converted to ITU Rec. 709. Additionally, the RH10UC can operate as a standalone HD-SDI Frame Synchronizer. The RH10UC is compatible with AJA's FR1 or FR2 frames.

### Features

- Broadcast-Quality 10-bit SD to HD Upconverter
- Motion-adaptive de-interlacing
- Frame Synchronizer function with Genlock input
- Selectable aspect ratio conversion
- Selectable HD output format
- HD-SDI stand-alone Frame synchronizer mode
- Passed embedded audio from SD-SDI to HD-SDI
- 5 Year Warranty

### Specifications

- Input Formats:**  
• 525/59.94 • 625/50 • SMPTE 259M • 292M
- Output Formats:**  
• 1080i 50/59.94 • 720p 59.94 Hz (50Hz input requires 50 Hz output)
- Upconversion:**  
• Motion adaptive • Multi-point interpolation • 10-bit processing
- Inputs:**  
• HD/SD SDI • BNC
- Reference:**  
• 2 x BNC • looping
- Outputs:**  
• Input Loop • 2 x BNC • Equalized HD-SDI • 4 x BNC
- User Controls:**  
• Mode: Upconvert • HD Frame Synchronizer • Output Format • Aspect Ratio Convert Select • Output Timing
- Size:**  
• Fits AJA R-Series Frames
- Power:**  
6 watts

## RH10MD High Definition Downconverter and DA

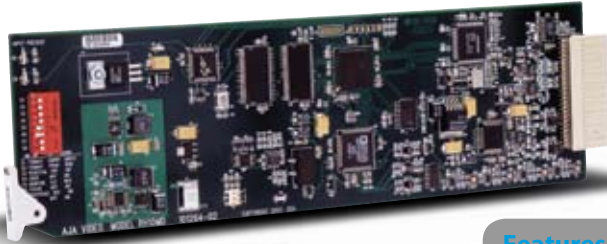
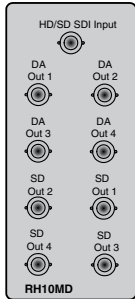

The RH10MD is a 10-bit broadcast-quality HD downconverter and HD/SD-SDI distribution amplifier. There are 4 re-clocked HD/SD-SDI outputs and four down-converted SD outputs. The SD outputs can be individually configured as analog or SDI - analog can be component or composite. All HD formats are supported including 24p/psf with 3:2 pulldown. The SD output can be formatted for either 4:3 or 16:9 monitors. For 4:3 monitors both Letterbox and Crop modes are supported. The RH10MD is also dual-rate (HD/SD) and will support SDI inputs. 4 Ch AES embedded audio is passed through to the SDI outputs. The RH10MD is compatible with AJA's FR1 or FR2 frames.

### Features

- Broadcast-Quality 10-bit HD Downconverter
- Re-clocking 1x4 HD/SD-SDI DA
- Multi-Standard HD-SDI or SDI Input
- SDI and Component/Composite Analog Outputs
- 3/2 Pulldown for 23.98/24 Hz p/psf inputs
- Full 10-bit Data Path, Multi-point Interpolation
- Configurable for 16:9 or 4:3 Monitors
- Letterbox and Crop Modes
- 4:3 Safe-Zone Graticule
- Passes embedded audio from HD-SDI to SD-SDI
- 5 Year Warranty

### Specifications

#### Formats:

- HD: 1080i 50/59.94/60 Hz • 1080p/psf 23.98/24/25/29.97/30 Hz • 720p
- 23.98/24/25/29.97/30/50/60 Hz

#### Inputs:

- HD-SDI or SDI SMPTE 259/292/296
- 10-bit • BNC

#### Outputs:

- SDI • SMPTE 259M • 10-bit • BNC
- YPbPr • SMPTE • EBU-N10 • Betacam RGB • NTSC • PAL • Y/C (S-Video) • 10-bit • 3 x BNC

#### Downconversion:

- Multi-point interpolation • 10-bit processing • 3:2 conversion for 23.98/24p/psf inputs

#### User Controls:

- (External Dipswitch) • Output Video Format • 4:3/16:9 Monitor Select • Letterbox/Crop • Pedestal (Output) • 4:3 Safe-Zone Graticule Overlay

#### Size:

- Fits AJA R-Series Frames

#### Power:

- 5 watts

## RD10MD2 Dual HD To SD Downconverter



The RD10MD2 is a 10-bit broadcast-quality Dual HD down converter. Channels 1 and 2 are fully independent. Channel 1 has 2 re-clocked HD/SD SDI outputs and channel 2 has 1. Both Channel 1 and 2 have 2 down converted outputs, which can be independently configured as SDI or composite analog. All HD formats are supported including 24p/psf with 3:2 pulldown. The SD output can be formatted for either 4:3 or 16:9 monitors. For 4:3 monitors both Letterbox and Crop modes are supported. The RD10MD2 is also dual-rate (HD/SD) and will support SDI inputs. The RD10MD2 is compatible with AJA's FR1 or FR2 frames.

### Features

- Dual Independent channel HD to SD down conversion
- Re-clocking HD/SD-SDI input loop outputs
- Multi-Standard HD-SDI or SDI Input
- SDI and Composite Analog Outputs
- 3/2 Pulldown for 23.98/24 Hz p/psf inputs
- Full 10-bit Data Path, Multi-point Interpolation
- Configurable for 16:9 or 4:3 Monitors
- Letterbox and Crop Modes
- 4:3 Safe-Zone Graticule
- 5 Year Warranty

### Specifications

#### Formats:

- HD: 1080i 50/59.94/60 Hz • 1080p/psf 23.98/24/25/29.97/30 Hz • 720p
- 23.98/24/25/29.97/30/50/60 Hz

#### Inputs:

- HD-SDI or SDI SMPTE 259/292/296
- 10-bit • BNC

#### Outputs:

- Each Channel has two outputs configurable for either SDI (SMPTE 259M - (10-bit) or analog composite NTSC/PAL • 2x BNC Channel 1 has two re-clocked loop-through outputs • 2x BNC • Channel 2 has one re-clocked loop-through output • 1 BNC

#### Downconversion:

- Multi-point interpolation • 10-bit processing 3:2 conversion for 23.98/24p/psf inputs

#### User Controls:

- External Dipswitch • Output Video Format • 4:3/16:9 Monitor Select • Letterbox/Crop • Pedestal (Output) • 4:3 Safe-Zone Graticule Overlay

#### Size:

- Fits AJA R-Series Frames

#### Power:

- 7 watts

## RH10DA Dual Rate HD/SD-SDI 1x8 Re-clocking Distribution Amplifier

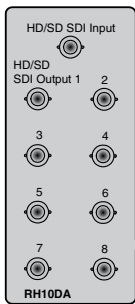

The RH10DA is a multi-standard Dual Rate 1x8 HD/SD-SDI Distribution Amplifier. The input is re-clocked and equalized to 75/300 meters (HD/SD) of coax cable. The RH10DA automatically configures to 143, 177, 270, 360mb, or 1.485gb SDI inputs. The re-clock function can be by-passed with an on-board jumper.

### Features

- Dual Rate HD-SDI/SDI
- Equalizing and Re-clocking, 8 outputs
- Automatic Input configuration
- Passes embedded audio
- 5 Year Warranty

### Specifications

- Input:**
- SMPTE 259M/292M/296M • BNC
- Output:**
- SMPTE 259M/292M/296M • 8 x BNC
- Size:**
- Fits AJA R-Series Frames
- Power:**
- 3 watts

## R20DA 1x8 SD-SDI Distribution Amplifier, Multi-format

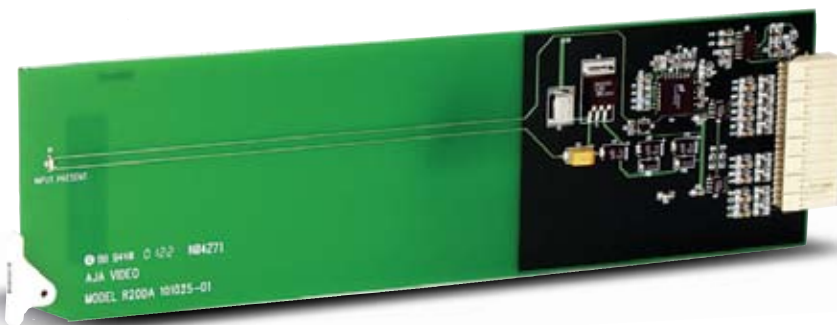
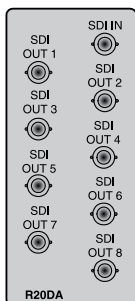

The R20DA is a multi-standard, 1x8 SD-SDI Distribution Amplifier. The SDI input is re-clocked and equalized to 300 meters of cable. In addition, the multi-standard feature allows the R20DA to automatically adapt to 143, 177, 270, or 360 Mb SDI inputs.

### Features

- Re-clocking, Equalizing SDI Distribution Amplifier
- SD-SDI Input
- 8 SDI Outputs
- Multi-Standard: 143/177/270/360 Mb
- Passes embedded audio
- 5 Year Warranty

### Specifications

- Input:**
- SD-SDI (SMPTE 259M) • BNC 143 • 177 • 270 • 360 Mb, auto select
- Outputs:**
- SD-SDI (SMPTE 259M) • 8 x BNC
  - Re-Clocked • Equalized
- Size:**
- Fits AJA R-Series Frames • Compatible with Leitch 6800 Series Frames
- Power:**
- 3 watts

## R20AD Component or Composite Analog to SD-SDI Converter, 10-bit

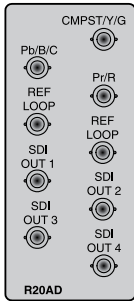

The R20AD provides excellent-quality 10-bit conversion of component or composite analog video to SD-SDI with EDH. The R20AD accepts YPbPr (SMPTE, EBU-N10), Betacam, or RGB component inputs and NTSC/PAL or Y/C (S-Video) composite inputs. The R20AD features a 4 Line Adaptive Comb Filter for high quality decoding of composite sources. The comb filter can be switched to 2 line, or notch modes for minimum delay requirements. The R20AD also accommodates the optional FSG card (Frame Sync) for synchronizing the output video relative to an external reference. NTSC/PAL configuration is automatic. Video format, AGC, H/V blanking, and pedestal are all user configurable.

### Features

- Excellent-Quality 10-bit Universal A/D Conversion
- Component, Composite or Y/C Analog Input
- 4 Line Adaptive Comb Filter
- Full 10-bit Data path, 2x Oversampling
- YPbPr, Betacam, or RGB Component Formats
- NTSC or PAL Composite Formats
- AGC Mode
- 4 SDI Outputs with EDH
- Color Bar Generator
- Optional Frame Synchronizer
- 5 Year Warranty

### Specifications

- Inputs:**
- YPbPr - SMPTE • EBU-N10 • Betacam • RGB - NTSC • PAL • Y/C (S-Video) • 3 x BNC
- Reference:**
- Passive Loop • 2 x BNC
- Outputs:**
- SD-SDI (SMPTE 259M) w/EDH • 4 x BNC
- A/D Converters:**
- 10-bits • 2x oversampling
- Frequency Response:**
- Y +/- .15dB to 5.5MHz • C +/- .15dB to 2.5MHz • Less than .5% K Factor (2T)
- User Controls:**
- Input Video Format • Pedestal Present/Not Present • Narrow/Wide Blanking • AGC On/Off • EDH On/Off
  - Test Pattern • Output Timing adj. (w/Frame Sync option)
- Size:**
- Fits AJA R-Series Frames • Compatible with Leitch 6800 Series Frames
- Power:**
- 7 Watts (8 watts w/Frame Sync option)

## R20CE SD-SDI to Component and Composite Analog Converter, 10-bit

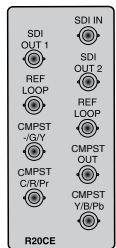

The R20CE SD-SDI to Analog Video Converter provides excellent-quality 10-bit conversion of SD-SDI to both component and composite video formats simultaneously. The 4 analog outputs are user configurable to NTSC/PAL, Y/C (S-Video), YPbPr (SMPTE, EBU-N10), Betacam, or RGB. The component and composite outputs are completely independent including optimum chroma filtering for each and independent pedestal configuration. The R20CE also features an exclusive PLL jitter filter/memory to reduce the effects of SDI jitter on the output analog video. This feature, along with the precision 4x oversampled D/A filters, provides the highest-quality analog outputs - including very low phase noise in composite outputs. The optional FSG (Frame Sync/Genlock) Module allows genlock to an external reference with full timing adjustment. Without the FSG Module, the reference input provides color frame timing.

### Features

- Excellent-Quality 10-bit Universal D/A Conversion
- Full 10-bit Data path, 4x Oversampling
- SD-SDI Input, 2 Re-clocked, Loop-Thru SDI Outputs
- Simultaneous Component and Composite Analog Outputs
- YPbPr, Betacam, or RGB Component Formats
- NTSC or PAL Composite Formats
- Digital Noise Reduction
- Optional Frame Synchronizer Allows Genlock to Reference, Full Timing Adjustment

### Specifications

- Input:**
- SD-SDI (SMPTE 259M), 1 x BNC
- Reference:**
- Passive loop, 2 x BNC
- Outputs:**
- (Simultaneous Component and Composite output) • YPbPr - SMPTE • EBU-N10 • Betacam • RGB • NTSC • PAL • Y/C (S-Video) • 3 x BNC • NTSC/PAL or Sync • 1 x BNC • Re-clocked loop-thru SDI • 2 x BNC
- D/A Converters:**
- 10-bits • 4x oversampling • Clock Jitter Filtering to 2.5Hz
- Frequency Response:**
- Y +/- .15dB to 5.5MHz • C +/- .15dB to 2.5MHz (Component) • C +/- .15dB to 1.3MHz (Composite) • Less than .5% K Factor (2T)
- User Controls:**
- Output Video Format • Pedestal On/Off • Narrow/Wide Blanking • Digital Noise Reduction • Output Timing Adj. (w/Frame Sync option)
- Size:**
- Fits AJA R-Series Frames • Compatible with Leitch 6800 Series Frames
- Power:**
- 7 Watts (8 watts w/Frame Sync option)

## FSG Frame Sync/Genlock Module

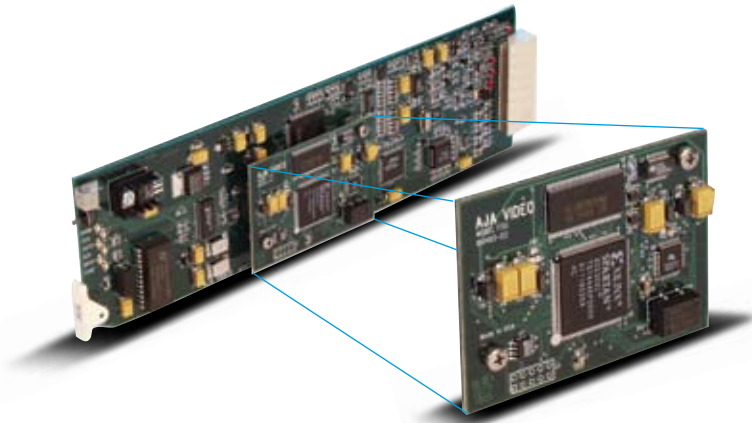

The FSG Frame Sync/Genlock Module is an optional upgrade to AJA's R20 series encoders and decoders. The FSG Module provides user adjustable output timing relative to an external sync reference. Also, a delay mode provides adjustable delay with respect to the video input. In addition to the frame sync and delay functions, when installed on AJA R20 series encoders, the FSG Module allows the encoder to genlock to an external reference.

### Features

- Optional Frame Sync R20CE, R20D, and R20AD
- External or Input Timing Reference
- Full Output Timing Adjustment
- Passes Vertical Interval Data
- 10-bit Data Path

### Specifications

- Formats:**
- 525/625 Line Component Digital
- Data Path:**
- 10 bits
- Power:**
- 2 watts

## R10CE 1x4 SD-SDI DA and 10-bit Component/Composite Analog Converter

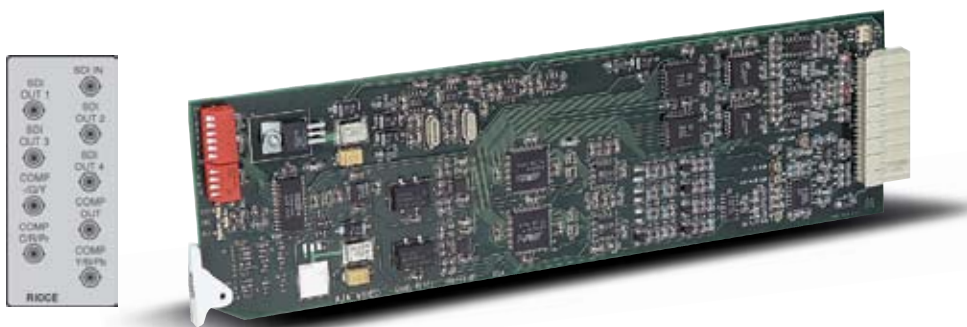

The R10CE is a SD-SDI distribution amplifier and universal monitoring D/A converter. The R10CE provides four equalized and re-clocked SDI outputs along with four analog monitoring outputs. The four analog outputs can be configured to a wide variety of formats including NTSC/PAL, YC (S-Video), YPbPr (SMPTE, EBU-N10), Betacam or RGB. A PLL jitter filter/memory reduces the effects of SD jitter on the analog outputs. The R10CE fits the AJA R-Series Rack Mount Frames, and is compatible with other standard racks.

### Features

- Universal Monitoring SDI DA
- SD-SDI Input
- 4 Re-Clocked SD-SDI Outputs
- 4 10-bit Component/Composite Analog Outputs
- YPbPr, Betacam, or RGB Component Formats
- PLL Jitter Filter
- Built-In Test Pattern

### Specifications

- Inputs:**
- SD-SDI (SMPTE 259M) • 1x BNC
- Outputs:**
- YPbPr - SMPTE • EBU-N10 • Betacam
  - RGB • 3x BNC • Or NTSC • PAL • 3x BNC
  - Or NTSC/PAL and YC • 3x BNC • SDI
  - Re-Clocking • 4x BNC
- User Controls:**
- External Dipswitch • Video Format
  - Pedestal • Vertical/Horizontal Blanking
- Power:**
- 4 Watts

## R5CE 1x4 SD-SDI DA and Component/Composite Analog Converter

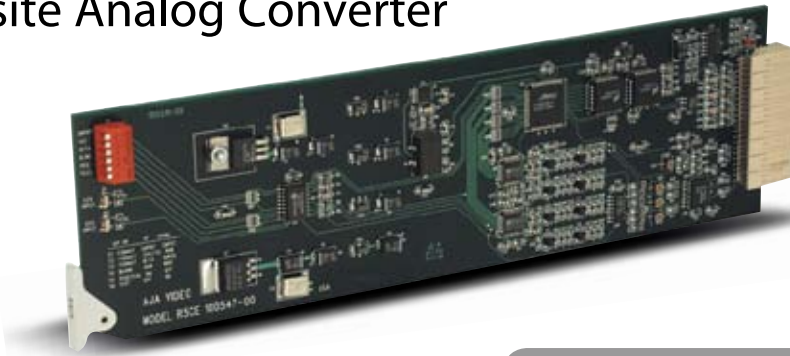
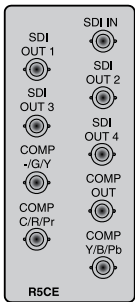

The R5CE is a SD-SDI distribution amplifier and universal monitoring D/A converter. The R5CE provides four equalized and re-clocked SDI outputs along with four analog monitoring outputs. The four analog outputs can be configured to a wide variety of formats including NTSC/PAL, Y/C (S-Video), YPbPr (SMPTE, EBU-N10), Betacam or RGB. A PLL jitter filter/memory reduces the effects of SDI jitter on the analog outputs. An exclusive feature of the R5CE is a 10- to 8-bit dithering circuit which removes contouring in the analog outputs. Additionally, the R5CE features user selectable pedestal and H&V blanking.

### Features

- Universal Monitoring SD-SDI DA
- SD-SDI Input
- 4 Re-clocked SD-SDI Outputs
- 4 Component/Composite Analog Outputs
- YPbPr, Betacam, or RGB Component Formats
- 10-bit to 8-bit Dithering
- PLL Jitter Filter
- Built-in Test Pattern

### Specifications

- Input:**
- SD-SDI (SMPTE 259M) • BNC
- Outputs:**
- SD-SDI (SMPTE 259M) • 4 x BNC • Re-Clocked • Equalized • NTSC/PAL Analog • 1 x BNC • YPbPr – SMPTE • EBU-N10
  - Betacam • RGB • or 3 x NTSC/PAL • or 1 NTSC/PAL and Y/C (S Video) 3 x BNC
  - Jitter Filtering to 2.5 Hz
- User Controls:**
- (External Dipswitch) • Video Format • Pedestal • H/V Blanking •
- Frequency Response:**
- +/- .25 dB to 5 MHz
- Size:**
- Fits AJA R-Series Frames • Compatible with Leitch 6800 Series Frames
- Power:**
- 6 watts

## RD5CE Two Channel SD-SDI to Component/Composite Analog Converter

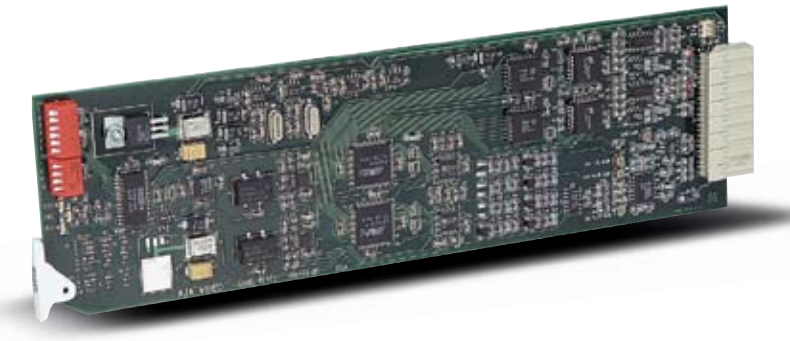
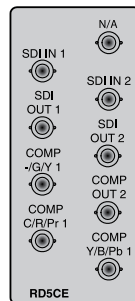

The RD5CE is a low-cost, dual-channel, universal video D/A converter. The RD5CE supports 2 completely separate channels of SD-SDI to analog conversion. Channel 1 can output component or composite analog video including YPbPr (SMPTE, EBU-N10), Betacam, RGB, composite or YC (S-Video). Channel 2 can output composite or Y. Both SDI inputs have a re-clocked SDI loop-thru output.

### Features

- Low-Cost Universal D/A Conversion
- Two Separate Channels
- SD-SDI Inputs, Re-clocked Loop-thru SDI outputs
- CH 1 outputs Component or Composite
- CH 2 outputs Composite or Y

### Specifications

- Inputs:**
- 2 Channels SD-SDI (SMPTE 259M) • 2 x BNC
- Outputs:**
- CH 1 Output: YPbPr-SMPTE • EBU-N10 • Betacam • RGB • NTSC/PAL • Y/C (S-Video) • 3 x BNC • CH 2 Output: NTSC/PAL • Y • 1xBNC • SDI Looping Output • 2 x BNC
- User Controls:**
- Dipswitch (Separate control for each channel) • Video Format • Pedestal • H/V Blanking
- Frequency Response:**
- +/- .25dB to 5 Mhz Y • +/- .25dB to 1.3 MHz C (component) • +/- .25dB to 1.3 MHz C (composite) • <1.5% Differential Gain • <1.5 Degree Differential Phase
- Size:**
- Fits AJA R-Series Frames • Compatible with Leitch 6800 Series Frames
- Power:**
- 7.5 watts



## RD20DA Dual Channel SD-SDI Distribution Amplifier

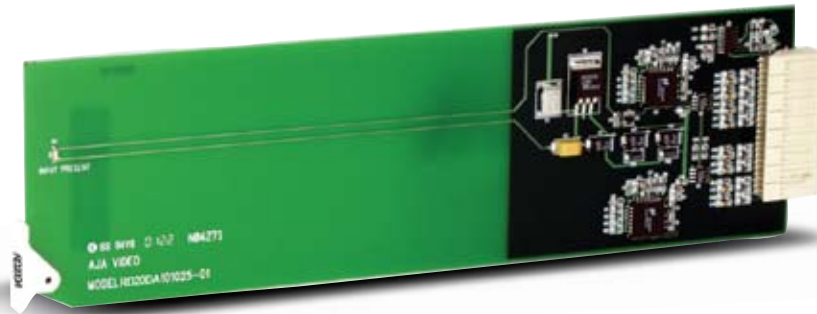
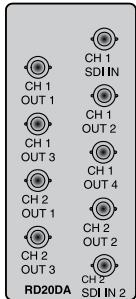

The RD20DA is a multi-standard, 2-channel, 1x4 and 1x3 SD-SDI Distribution Amplifier. The SDI input is re-clocked and equalized to 300 meters of cable. In addition, the multi-standard feature allows the RD20DA to automatically adapt to 143, 177, 270, or 360 Mb SDI inputs.

### Features

- 2 Channel Re-Clocking, Equalizing SDI Distribution Amplifier
- 2 Separate SDI Inputs,
- 1x3, 1x4 SDI Outputs
- Multi-Standard: 143/177/270/360 M2

### Specifications

- Input:**
- 2 Separate SD-SDI (SMPTE 259M) • BNC
  - 143 • 177 • 270 • 360 Mb • auto select
- Outputs:**
- Ch 1: 4 SDI (SMPTE 259M) • Ch 2: 3 SDI (SMPTE 259M) • Re-Clocked • Equalized
- Size:**
- Fits AJA R-Series Frames • Compatible with Leitch 6800 Series Frames
- Power:**
- 3 Watts

## R44E Four Channel SD-SDI to Composite Analog Converter

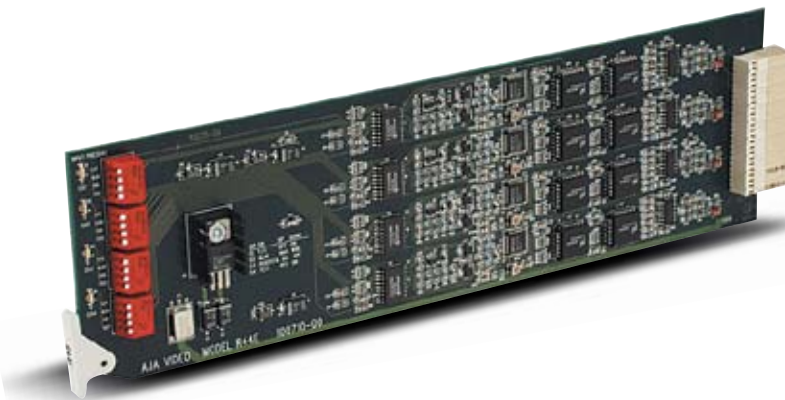
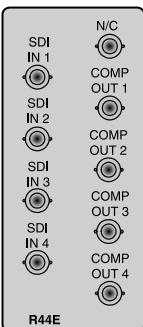

The AJA Video R44E provides four composite analog monitoring outputs from four separate SD-SDI inputs. Each channel has a separate D/A converter with a 10-bit DAC and 8-bit broadcast encoding. Values below black and above white are not clipped. Each channel has a test pattern generator with separate user selectable blanking controls. The R44E also features automatic NTSC or PAL configuration.

### Features

- 4 Channel SD-SDI to NTSC/PAL Converter
- 4 Separate SD-SDI Inputs
- 4 Separate Composite Analog Outputs
- Built In Test Pattern
- Configurable Pedestal
- R44E allows 40 Channels of Conversion in 2 RU

### Specifications

- Inputs:**
- 4 CH SD-SDI (SMPTE 259M) Inputs • 4 x BNC
- Outputs:**
- 4 NTSC/PAL, 4 x BNC
- User Controls:**
- Dipswitch (Separate control for each channel)
  - Composite/Y • Pedestal • H/V Blanking
- Frequency Response:**
- +/- .25 dB to 5 MHz
- Size:**
- Fits AJA R-Series Frames • Compatible with Leitch 6800 Series Frames
- Power:**
- 8 watts

## C-Series Converters



The C-Series converter products are designed to efficiently adapt 8-bit or 10-bit parallel digital video equipment to serial digital interfaces or serial digital interfaces to parallel digital interfaces. The C-Series converters attach directly to the "D" connectors of parallel equipment or BNC connector for serial equipment – eliminating the need for expensive and unreliable parallel Digital cables. At only .65 inches (16.5mm) wide, the C10 converters can fit on even the highest density parallel serial equipment. A wide range of C-Series products are available for any budget, from single-format only to multi-format with auto configuration and crystal PLL jitter filter. Requires power supply (C10WP or C10WP-U, below). Note: The C series converters do not cross formats from Component to Composite Digital or Composite Digital to Component Digital.

### Features

- Parallel to Serial, Serial to Parallel Video Conversion
- Multi-Format, Multi-Standard
- Auto Configuration To Component/Composite, 525- or 526-line
- Dither Mode For Proper 10-bit To 8-Bit Conversion
- Ancillary Data Filter Blocks, Audio/Unwanted Data
- Crystal PLL Jitter Filter Available
- Wide Range of Models Available

### Specifications

#### Serial Interface:

- SMPTE 259M-A, B, C • Serial I/O • BNC

#### Parallel Interface:

- SMPTE 125M (4:2:2) • SMPTE 244(4fsc NTSC) • EBU Tech 3246/3276 (4:2:2)
- OEC 60B 170/6 (4fsc PAL) • Parallel I/O
- D-Connectors

#### Return Loss:

- >15dB, 5-270Mhz

#### Frequency Response:

- +/- .25dB to 5 Mhz Y • +/- .25dB to 2.5 MHz C (component) • +/- .25dB to 1.3 MHz C (composite) • <1.5% Differential Gain • <1.5 Degree Differential Phase

#### Cable EQ:

- 0-300 meters • Belden 8281 typical

#### Power:

- 7.5 watts

#### Size:

- 4" x 2.25" x .65" (102mm x 57 mm x 16.5mm)

## C-Series Power Supplies



### Specifications

- 100-240v, 50/60Hz Universal input
- 5 volt regulated output
- 7.5 watt capacity
- Latching output connector

### C10WP

The C10WP is a miniature high quality switching power supply for AJA's C-Series products. Custom manufactured for AJA, the C10WP is so small it does not cover the adjacent socket in power strips. With a 2x power over-rating and a latching connector, the C10WP meets the high reliability requirements of the professional video industry.



### Specifications

- 100-240v, 50/60Hz Universal input
- 5 volt regulated output

### C10WP-U

The C10P-U is an in-line universal input version which can accept a power cord anywhere in the world.

For more information please visit:  
[www.aja.com](http://www.aja.com)



## Notes



#### **Incredible 5 Year Warranty**

All AJA Video Converters carry a 5-year warranty from the date of purchase against defects in material and workmanship. AJA Video, at its option, will repair or replace each defective product with a similar or better product. This warranty shall be limited to defects which were not caused by misuse, abuse, improper handling, tampering or attempts to repair by any unauthorized repair service. This warranty is limited solely to the above and only for the period set forth. The manufacturer will not be liable for any loss or damage incidental or consequential of any kind, whether based on warranty, contract or negligence arising in connection with the sale, use or repair of the product. The manufacturer's maximum liability shall not in any case exceed the sale price.

#### **About AJA Video Systems, Inc.**

Since 1993, AJA Video has been a leading manufacturer of video interface and conversion solutions, bringing high-quality, cost-effective digital video products to the professional broadcast and post-production markets. AJA offers the I/O, KONA and XENA desktop video products, miniature stand-alone converters, and a complete line of rack mount interface and conversion cards and frames. With a headquarters and design center located in Grass Valley, California, AJA Video offers its products through an extensive sales channel of dealers and systems integrators around the world. For further information, please see our website at [www.aja.com](http://www.aja.com)

**B e c a u s e   i t   m a t t e r s .**



**AJA Video Systems Inc.**  
Grass Valley, California

[www.aja.com](http://www.aja.com) • [sales@aja.com](mailto:sales@aja.com) • [support@aja.com](mailto:support@aja.com)